

GE
Grid Solutions

Intellix™ BMT 330 Installation Manual

Bushing Monitoring and Partial Discharge
Detection for Transformers



Building a world that works

Contents

Topic	Page
1 Introduction	6
1.1 Product Overview	6
1.2 Scope	6
1.3 Abbreviations & Definitions	6
2 Safety	7
2.1 Symbols	7
2.2 Installer Safety	7
3 Technical Specifications	8
3.1 Measurements	8
3.2 Environmental	8
3.3 Power	8
3.4 Type Tests	9
4 Pre-Installation	10
4.1 Location	10
4.2 Requirements	10
4.3 Base & Access	11
4.4 Communications & Power Cable Runs	11
4.5 Bushing Adaptor Cable Runs	11
5 Installation	13
5.1 Mounting	15
5.2 Bushing Adaptor Connections	15
5.3 High Frequency Current Transformer (HFCT) Connection	20
5.4 Magnetically-Mounted Temperature Sensors	22
5.5 Communications Connections	25
5.6 Cabinet Connections	25
5.7 Configuration and commissioning	35
5.8 Decommissioning	35
Appendix A Mounting Stand & Sun Hood	37
Appendix B Parts and Tools List	41
B.1 GE-supplied items (shipped with the product)	41
B.2 GE Field Service Engineer (FSE)-supplied items	42
B.3 Customer-supplied Items	42
Appendix C Connecting Coaxial Cables	44
C.1 Routing the Coaxial Cables	44
C.2 Required Materials & Tools	44
C.3 Coaxial Cables Preparation	45
C.4 Connecting to the Bushing Adaptor	45
C.5 Connecting to the Grounding Switch	46
C.6 Connecting to the Neutral CT	47
Appendix D Bushing Adaptor Circuit Integrity Test Record	49
D.1 Required Material	49
D.2 Test Procedure	49
Appendix E Communications Module Setup	58
E.1 Network Settings	58
E.2 EasyConnect software installation	59
E.3 Communications module configuration	62

Appendix F Front Panel Lights.....	67
Appendix G Troubleshooting.....	68
Contact & Copyright Details	69

List of Figures and Tables

<u>Item</u>	<u>Page</u>
Table 1-1: Installation materials.....	6
Table 3-1: Measurements.....	8
Table 3-2: Environmental.....	8
Table 3-3: Power.....	8
Table 3-4: Type Tests	9
Figure 5-1: General installation layout - single transformer	13
Figure 5-2: General installation layout - Bank of 3 single phase transformers.....	13
Figure 5-3: Rear side of the product door	14
Figure 5-4: Inside the product cabinet	14
Figure 5-5: Bushing Adaptor - without top cover	16
Figure 5-6: Bushing Adaptor - with top cover	16
Figure 5-7: Bushing Adaptor with cap	17
Figure 5-8: Bushing Adaptor with initial threads covered in grease.....	18
Figure 5-9: Bushing Adaptor with all threads covered in grease	18
Figure 5-10: Liquid-tight fitting thread.....	19
Figure 5-11: Bushing adaptor terminal block.....	19
Figure 5-12: Tightening order	20
Figure 5-13: HFCT cannot be installed if a switch is on cable from the Neutral Bushing to ground ...	21
Figure 5-14: HFCT installed on cable from the Neutral Bushing (H0) directly to ground	21
Figure 5-15: Star configuration (Y- Connection).....	21
Figure 5-16: HFCT installed after the switch on cable from the Neutral Bushing to ground	22
Figure 5-17: HFCT - example	22
Figure 5-18: MMTS rear view	23
Figure 5-19: MMTS front view.....	23
Figure 5-20: MMTS side view - #1.....	23
Figure 5-21: MMTS #1 with jumper.....	24
Figure 5-22: MMTS #2/3 without jumper	24
Figure 5-23: Fibre optic module.....	25
Figure 5-24: Earth adjacent to the fuse holders	25
Figure 5-25: Position of primary protective earth bonding lug	26
Figure 5-26: Ambient sensor - raised	26
Figure 5-27: Ambient sensor - extended.....	26
Figure 5-28: Bushing adaptor connections	27
Figure 5-29: PCB phase inputs - Secondary (left), Primary (middle) & Neutral CT (right)	28
Figure 5-30: CANbus Connection on the DIN rail	29
Figure 5-31: Copper Ethernet	30
Figure 5-32: Fibre optic module.....	31
Figure 5-33: Fibre optic connections.....	32
Figure 5-34: GPS antenna connection point	32
Figure 5-35: Cabinet - external top right - GPS antenna	34
Figure 5-36: Relay board (schematic)	34
Figure 5-37: Relay connections (right) and Mains (left)	34
Table 5-1: Relay connections.....	35

Figure A-1: Upper (or transport) stand	37
Figure A-2: Lower stand.....	38
Figure A-3: Sun hood.....	39
Figure A-4: Intellix™ BMT 330 with stand and sun hood attached	40
Table B-1: GE-supplied items	41
Table B-2: GE FSE-supplied items	42
Table B-3: Customer-supplied items.....	42
Table C-1: Required materials	44
Table C-2: Required tools.....	44
Table C-3: Coaxial cables preparation.....	45
Table C-4: Connecting to the Bushing Adaptor	46
Table C-5: Connecting to the grounding switch.....	47
Table C-6: Connecting to the Neutral CT	47
Figure D-1: Coax BNC to clips cable	49
Figure D-2: 2-pin connector and release key	49
Figure D-3: Disconnection of coaxial cables	50
Figure D-4: AA-170 - USB serial port	51
Figure D-5: 100 points and 'Set full range'	51
Figure D-6: Save calibration as "open"	52
Figure D-7: Save "open" calibration data	52
Figure D-8: Open calibration.....	53
Figure D-9: Short calibration.....	53
Figure D-10: Load calibration	53
Figure D-11: Use calibration data	53
Figure D-12: Bushing adaptor measurement	53
Figure D-13: Data analysis	54
Figure D-14: Resistance between cable shield and ground	55
Figure D-15: R1 resistance measurement	55
Figure D-16: R2 resistance measurement	56
Table D-1: Results	57
Figure E-1: Communication options between the BMT 330 and a customer network.....	58
Table E-1: Default TCP Port settings for communications module.....	58
Figure E-2: Network status	58
Figure E-3: EasyConnect 4.10.0.zip file	59
Figure E-4: EasyConnect 4.10.0 folder.....	59
Figure E-5: EasyConnect Setup.exe file	60
Figure E-6: License Agreement.....	60
Figure E-7: Choose Destination Location.....	61
Figure E-8: Ready to Install the Program.....	61
Figure E-9: Setup Status	62
Figure E-10: InstallShield Wizard Complete	62
Figure E-11: EasyConnect Installation folder & shortcut	63
Figure E-12: EasyConnect main screen.....	63
Figure E-13: Upload Kalkitech module settings.....	64
Figure E-14: Protocol Configuration	64
Figure E-15: IP Configuration	65
Figure E-16: LAN settings.....	65
Figure E-17: Restart confirmation	66
Figure E-18: IP address confirmation	66
Table F-1: Front panel lights	67
Table G-1: Problems and Actions	68

Related Documents

Ref#	Title
CG-051	BMT 330 Pre-Installation Requirements
MA-018	BMT 330 User Manual
MA-019	BMT 330 Service Manual
WI-048	BMT 330 Commissioning Instructions
CG-058	BMT 330 Modbus Registers List
CG-049	BMT 330 DNP3 Objects & I/O Points Index
CG-050	BMT 330 IEC 61850 Objects & I/O Points Index

1 INTRODUCTION

1.1 Product Overview

Intellix™ BMT 330 (the product) is a monitoring system that continuously:

- measures the condition of transformer bushings (through changes in Capacitance and Power Factor) for one or two sets of three bushings in a single three-phase transformer, or three single-phase transformers.
- detects any Partial Discharges (PD) activity in the transformer main tank (measured as high frequency pulses).

All measurements and alarms can be reported to a remote monitoring centre via the standard RS-485 connection or one of the other available communications options. Alternatively, they can be manually downloaded locally using the USB cable. The product is supplied with PC configuration software that is used to set up the product. Refer to the Intellix™ BMT 330 User Manual.

The following sensors can be fitted:

- Three Bushing Adaptors (Primary input) connected to the tapping point of the bushings being monitored.
- (Optional) Three Bushing Adaptors (Secondary input) connected to the tapping point of a second set of bushings being monitored.
- Three Current Transformer (CT) sensors at the transformer(s) neutral (if available).
- Three magnetically-mounted temperature sensors (MMTS) mounted on the transformer tank(s) to measure the transformer top oil temperature.
- A combined ambient temperature and humidity sensor mounted at the bottom of the product cabinet.

1.2 Scope

This manual details the installation tasks for the product.

1.3 Abbreviations & Definitions

Table 1-1: Installation materials

Abbreviation	Meaning
BMT	Bushing Monitor for Transformers
HFCT	High Frequency Current Transformer
HV	High Voltage
LOTO	Lock Out, Tag Out procedure
LV	Low Voltage
PD	Partial Discharge

2 SAFETY

2.1 Symbols

The meaning of symbols used on the Intellix™ BMT 330:



Caution. Refer to the Installation Manual / User Manual to prevent death, bodily injury, equipment damage or loss of data.



Electrical Hazard. Risk of electric shock.



Primary Protective Earth connection.

The meaning of safety symbols used in this manual:



Caution: A procedure, practice, or condition could cause death, bodily injury, equipment damage or loss of data.



Electrical Hazard: Risk of electric shock.



Laser radiation: LED transmitters for fibre optics are classified as IEC 60825-1 Accessible Emission Limit (AEL) Class 1. Class 1 devices are eye-safe to the unaided eye. Do not view directly with optical instruments.

2.2 Installer Safety



WARNING: All procedures in this manual must be followed. Any deviation could cause irreversible damage to the transformer being monitored and/or the Intellix™ BMT 330, and could lead to property damage, personal injury and/or death.



WARNING: Before installing the Intellix™ BMT 330, third parties must have received appropriate training for working at height. This includes, but is not limited to, 'Working at height' and 'Using Mobile Elevated Working Platforms'.

3 TECHNICAL SPECIFICATIONS

3.1 Measurements

Table 3-1: Measurements

Feature	Value
Input current measuring range	2 mA – 200 mA rms, 1% of reading
Relative phase angle accuracy	0.01 deg of angle
Maximum number of PD measured	200 pulses per cycle (50 to 60 Hz)
Measurement category for signal inputs	CAT III. 5 V AC rms, 200 mA; on each phase
Maximum bushing temperature at Bushing Adaptor	90 °C (194 °F)

3.2 Environmental

Table 3-2: Environmental

Feature	Value
Cabinet operating temperature range	-40 °C to +55 °C (-22 °F to +131 °F)
When equipped with multi-master comms option	-20 °C to +55 °C (-4 °F to +131 °F)
Operating humidity range	5 to 95% RH, non-condensing
Maximum operating altitude	2000 m (6500 ft) above sea level
Storage temperature range	-40 °C to +85 °C (-40 °F to +185 °F)
Minimum ambient temperature for installation and service activities	-20 °C (-4 °F)
Cabinet protection level	IP55
Bushing Adaptor protection level	IP66
Intellix™ BMT 330 weight	20 kg (44 lb)
Bushing Adaptor weight	350 gm (0.8 lb), typical
Bushing Adaptor operating temperature	-40 °C to +90 °C (-40 °F to +194 °F) at Bushing Tapping Point

3.3 Power

Table 3-3: Power

Feature	Value
AC Power supply requirement	100 to 240 V AC, 50 to 60 Hz, 1.24 to 0.41 A
Output relays (quantity 3)	Single Phase Change Over (SPCO), Maximum Rating (resistive load): 2 A @ 240 V AC, 2 A @ 30 V DC
Fuse (one each on Live and Neutral)	10 × 38 mm time delay 500 V, 3 A

3.4 Type Tests

Table 3-4: Type Tests

Category	Standard	Class/Level	Test
EMC Emissions	CISPR 11	A	Radiated & Conducted Emissions
	FCC part 15	A	Radiated & Conducted Emissions
	IEC 61000-3-2	A	Harmonic Current Emissions Limits
EMC Immunity	IEC 61000-4-2	IV	Electrostatic Discharge
	IEC 61000-4-3	III	Electro Magnetic Field Immunity
	IEC 61000-4-4	III	Electrical Fast Transients
	IEC 61000-4-5	III	Surge Immunity
	IEC 61000-4-6	III	Conducted RF Immunity
	IEC 61000-4-8	IV & V	Magnetic Field Immunity
	IEC 61000-4-11	III	Voltage Dips & Interruptions
	IEC 61000-4-12	X 2.5 kV & 1 kV	Oscillatory Wave
	IEC 61000-3-3	Pst 10 min, Plt 120 min	Voltage fluctuations & flicker
IEC 60255-5	5 kV, 2 kV & 500 V DC	Impulse, Dielectric & Insulation resistance testing	
Environmental	IEC 60068-2-1	-40 °C	Cold
	IEC 60068-2-2	55 °C	Dry Heat
Environmental	IEC 60068-2-6	10-500Hz, 1g operation 10-500Hz, 1g endurance	Vibration
	IEC 60068-2-30	55 °C, 95% RH	Damp Heat
	EN 60529	Cabinet – IP55, Adaptor – IP66	Degree of Protection
Safety	IEC 61010-1		2010 + Corr1
	EN 61010-1		2010
	UL 61010-1		3 rd Edition

4 PRE-INSTALLATION

4.1 Location

The Intellix™ BMT 330 requires an installation location with:

- an electrical supply of 230 V AC (1 A) or 110 V AC (2 A). The electrical supply must have an independent means of disconnection and be clearly identified with a label.
- a suitable site access to carry the product to its destination

Note: The dry weight of the product is approximately 20 kg.

- a base that can take the 30 kg distributed load and accommodate the product dimensions of

600 mm long × 400 mm wide × 200 mm deep.

There should be at least 750 mm clear space in front to allow access to the product.

In addition, the chosen location must:

- not interfere with the transformer cooling system, regular maintenance activities or operation of the electrical supply disconnection device.
- be within the maximum line length of the chosen communications method.

It is recommended that the Intellix™ BMT 330 be:

- installed sufficiently close to the transformer(s) so that the cable runs from the product to the bushings are likely to be less than 25 m.
- mounted on the transport stand (see Appendix A for dimensioned drawings).



It is not recommended that the product be mounted directly on the transformer. If this method of installation is being considered, contact GE Technical Support.

4.2 Requirements

Observe the following requirements to install the product:

- The transformer is to be de-energised, switched off and earthed for the duration of the installation process.
- Cable runs are required from the product location to the bushings.
- To facilitate Bushing Adaptor installation and test, the customer is responsible for supplying a safe and suitable working environment.



All coaxial cables from the Bushing Adaptors to the product *must* be run inside a protective electrically grounded metal conduit.



WARNING: If the equipment is installed or used in a manner not specified by the manufacturer, the protection provided by the equipment may be impaired



If working at heights is required during the product installation, it is the responsibility of the installer as a minimum to:

- Ensure that planned work complies with national and site regulatory requirements.
- Ensure that any third-party equipment to be used is suitable and safe before commencing work.
- Ensure that third parties have received appropriate training for working at height. This includes, but is not limited to, 'Working at height' and 'Using Mobile Elevated Working Platforms'.

4.3 Base & Access

The base should be level and sufficiently firm to allow the stand to be bolted down. See Appendix A for the required dimensions. Consider the following factors:

- The site should be readily accessible as the product weighs approximately 20 kg (44 lb).
- There should be 2 m (79 in.) headroom.
- If a new concrete pad is required, the dimensions should be at least 610 mm (24 in.) long × 1220 mm (48 in.) wide × 90 mm (3 ½ in.) deep, with an #3 (10 mm) steel reinforcing bar around the perimeter. This should be grounded and bonded in accordance with local practice and code.
- The product should never be mounted directly to the transformer without first consulting GE Technical Support.
- The intended AC supply is to be provided with a switch or circuit breaker so that it can be independently de-energised. The location of the switch or circuit breaker should be near the intended location of the product and within easy reach of the operator.

If the GE manufactured mounting stand has not been purchased, a stand should be constructed as outlined in Appendix A.

4.4 Communications & Power Cable Runs

If possible, communications and power cable runs from the intended product location to their sources should be pre-installed. See Figure 5-1 for the general installation layout.

4.5 Bushing Adaptor Cable Runs

If possible, Bushing Adaptor cable runs from the intended product location to the transformer bushings should be pre-installed. See Figure 5-1 for the general installation layout.



All coaxial cables from the Bushing Adaptors to the product cabinet *must* be run inside a protective electrically grounded metal conduit.



All installation activity should take place in ambient temperatures greater than $-20\text{ }^{\circ}\text{C}$ ($-4\text{ }^{\circ}\text{F}$) to prevent damage to connectors and cabling because they may become brittle at extreme low temperatures.



If working at heights is required during the product installation, it is the responsibility of the installer as a minimum to:

- ensure that planned work complies with national and site regulatory requirements.
- ensure that any third-party equipment to be used is suitable and safe before commencing work.
- ensure that third parties have received appropriate training for working at height. This includes, but is not limited to, 'Working at height' and 'Using Mobile Elevated Working Platforms'.



When installing conduit to Bushing Adaptors, ensure that the conduit drops away from the Bushing Adaptor body.

Details of recommended conduit and fittings are listed in Appendix B.

All Bushing Adaptors and HFCT cables are run into the product cabinet. Each of these coaxial cables must be properly identified using cable markers provided with the installation kit (see Appendix B) as follows:

- Cable for Primary input from phase A Bushing Adaptor: P1
- Cable for Primary input from phase B Bushing Adaptor: P2
- Cable for Primary input from phase C Bushing Adaptor: P3
- Cable for Primary input from spare single phase Bushing Adaptor (if available): P4
- Cable for Secondary input (if available) from phase A Bushing Adaptor: S1
- Cable for Secondary input (if available) from phase B Bushing Adaptor: S2
- Cable for Secondary input (if available) from phase C Bushing Adaptor: S3
- Cable for Secondary input (if available) from spare single phase Bushing Adaptor (if available): S4
- Cable from HFCT (single tank or single phase A, if available): N1
- Cable from single phase B (if available): N2
- Cable from single phase C (if available): N3
- Cable from spare single phase (if available): N4

The above coaxial cables are connected to the corresponding terminals of the grounding switch inside the product cabinet, such that the central wire is routed to the core side and the braid shield wire is routed to the shield side. See Appendix C.

5 INSTALLATION

Figure 5-1 illustrates the general installation layout of an Intellix™ BMT 330 with the required connections for a single transformer.

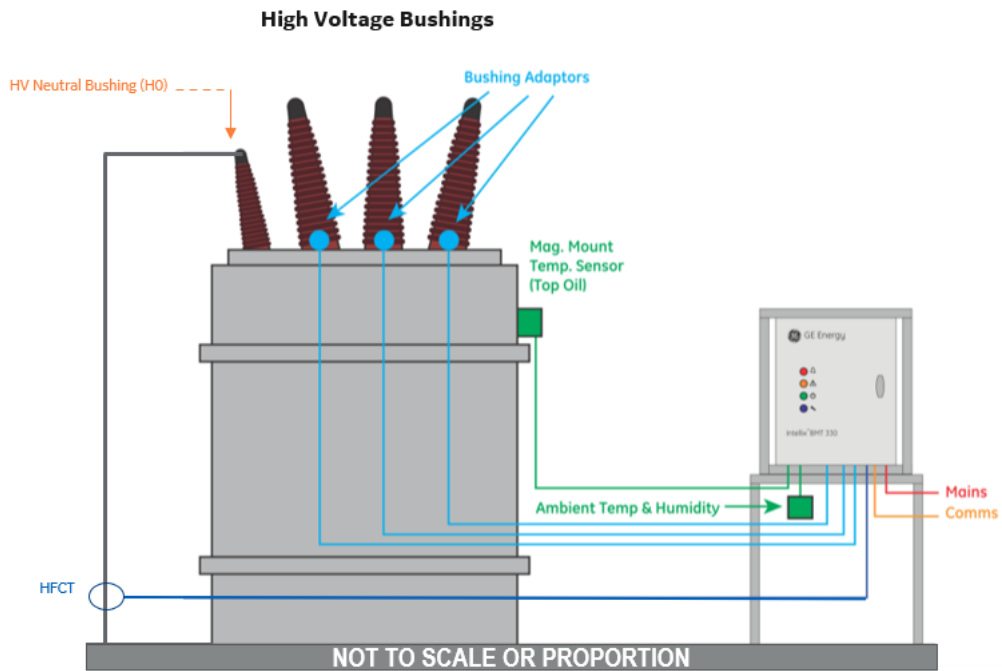

Figure 5-1: General installation layout - single transformer

Figure 5-2 illustrates the general installation layout of an Intellix™ BMT 330 with the required connections for a bank of three single phase transformers.

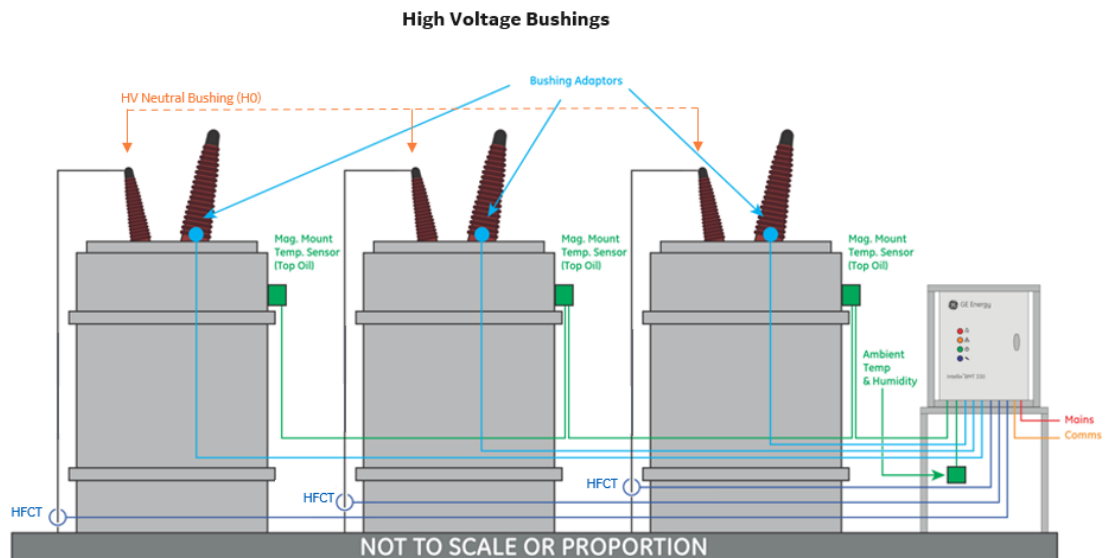

Figure 5-2: General installation layout - Bank of 3 single phase transformers



The product is supplied with factory default settings for all parameters, e.g. alarm thresholds. For optimal performance, specific settings are required for each installation.

Figure 5-3 shows the rear side of the product door.



Figure 5-3: Rear side of the product door

Figure 5-4 shows the key parts inside the product cabinet.

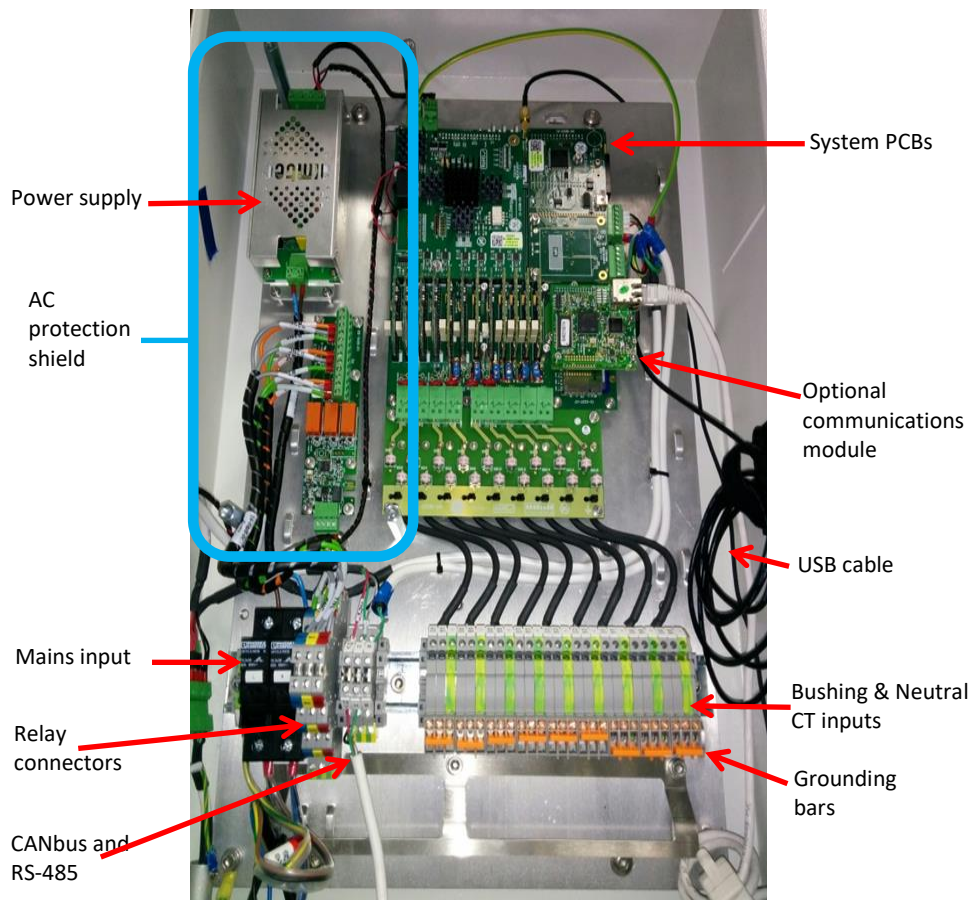

Figure 5-4: Inside the product cabinet

5.1 Mounting



WARNING: Do not attempt to install the product unless the transformer is de-energised and switched off.



WARNING: Ensure that the HV and LV bushings are grounded before installation of the product.



WARNING: Once installed, the product may have more than one source of supply. Disconnect all supplies at their source before accessing the cabinet for servicing. Follow LOTO procedures.



The product should not be mounted where it may interfere with the transformer cooling system or maintenance activities.



There should be at least 750 mm (30 in.) clearance in front of the product to allow access to the cabinet.



Contact GE Technical Support before mounting the product directly on the transformer.

The GE stand is shipped with the top portion of the stand inverted. Remove the hardware holding the stand together, then remove the top section which is inverted within the larger stand base, and assemble in an upright position reusing the original hardware.

- Use the diagram of the mounting stand footprint (see Appendix A) or the mounting stand itself (recommended) to mark at least one hole in each mounting tab from the mounting stand.
- Use adequate concrete anchors (not supplied) to anchor the mounting stand to the mounting surface.
- Ensure that the stand is on a horizontal level surface.

Note: Three mounting holes are available on each foot of the stand base, but only one hole is required for installation.

5.2 Bushing Adaptor Connections

A list of parts and tools required for the product installation is given in Appendix B.

Preparation of the coaxial cables is described in Appendix C.

The Bushing Adaptor is supplied assembled, but with both O-rings separately packed. In overview the installation is composed of the following steps:

- A pre-installation check is performed.
- Conductive grease is applied to thread (threaded Bushing Adaptor only).
- The whole Bushing Adaptor is screwed into the bushing tapping point.
- The top cover of the Bushing Adaptor is removed leaving the body in place as illustrated in Figure 5-5.

- A Bushing Adaptor circuit integrity test is performed.
- The cabling is attached through the top cover and O-ring.
- The top cover of the Busing Adaptor is re-attached as illustrated in Figure 5-6.

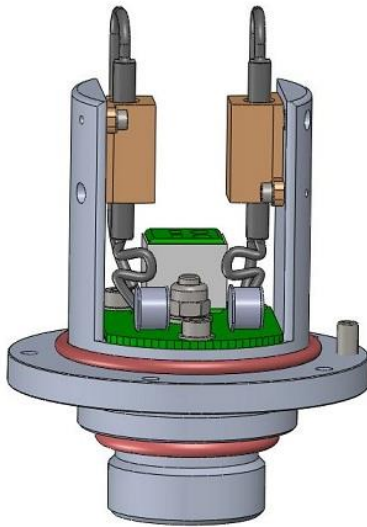

Figure 5-5: Bushing Adaptor - without top cover Figure 5-6: Bushing Adaptor - with top cover



The rubber O-rings must not be contaminated with grease during the assembly process.



Both ends of the coaxial cables for the Bushing Adaptor and Neutral CT must be prepared and fitted with pin terminals as described in Appendix C.



All coaxial cables from the Bushing Adaptors to the product cabinet *must* be run inside a protective electrically grounded metal conduit. See Appendix B.3 for recommended conduit and fittings.



If working at heights is required during the product installation, it is the responsibility of the installer as a minimum to:

- Ensure that planned work complies with national and site regulatory requirements.
- Ensure that any third-party equipment to be used is suitable and safe before commencing work.
- Ensure that third parties have received appropriate training for working at height. This includes, but is not limited to, 'Working at height' and 'Using Mobile Elevated Working Platforms'.

5.2.1 Bushing Adapter Caps

The Bushing Adaptors are shipped with a plastic-threaded cap as shown in Figure 5-7.



Figure 5-7: Bushing Adaptor with cap

When removing the original test tap caps from the bushings, first check that they fit the plastic-threaded cap from the new bushing adapter. If it is a good fit, continue with the Bushing Adaptor installation. *If the original test tap cap does not fit the plastic-threaded cap, halt the installation and contact GE Technical Support.*

5.2.2 Install a Bushing Adaptor

To install a Bushing Adaptor:

- 5.2.2.1 See Appendix D for the test procedure on how to verify the circuit integrity of the Bushing Adaptor.
- 5.2.2.2 Check Bushing ID reference against Bushing Adaptor ID reference.



WARNING: After connecting the Bushing Adaptor, it is crucial that the Bushing Adaptor circuit integrity tests in Appendix D are performed.

- 5.2.2.3 Remove the bushing test tap covers. Retain the tap covers in a safe place because they will be required in the future when decommissioning the product.
- 5.2.2.4 With clean hands, put the smaller O-ring in its seat as shown in Figure 5-6.
Note: There are two spare O-rings supplied in the shipping package of each Bushing Adaptor. Store these safely for future use should the Bushing Adaptor need to be re-installed.
- 5.2.2.5 Apply the conductive grease to the bushing adaptor threads. The high temperature anti-seize carbon conductive grease (supplied with the installation kit) must reach all threads. To start, apply an even amount of grease to the first few threads as shown in Figure 5-8.



Figure 5-8: Bushing Adaptor with initial threads covered in grease

As the bushing adaptor is installed into the tapping point of the bushing, the grease will work its way down ensuring an even coating across all threads as shown in Figure 5-9.



Figure 5-9: Bushing Adaptor with all threads covered in grease

- 5.2.2.6 Screw the complete Bushing Adaptor into the tapping point of the bushing. First just hand-tighten and check that the resistance between the Bushing Adaptor body and the bushing body is less than 5 Ω .

Note: If required, scrape a little paint off the bushing well to get a good conductive path, or alternatively, find another suitable grounded point so that ground continuity can be tested between the ground and the Bushing Adaptor body.

- 5.2.2.7 Tighten the Bushing Adaptor to the required torque defined in the installation drawing (46-XXXX) provided with each Bushing Adaptor. It is important to tighten the Bushing Adaptor in steps of 20 N m (15 lb ft) until you reach the final torque requirement to minimise mechanical stress.

Note: A suitable torque wrench is specified in Table B-3: Customer-supplied items.

- 5.2.2.8 Finally, re-check that the resistance between the Bushing Adaptor body and the bushing well is still less than 5 Ω .

- 5.2.2.9 Remove the five Allen key screws and remove the Bushing Adaptor top cover.

Note: Suitable tools are specified in Table B-3: Customer-supplied items.

- 5.2.2.10 Install a liquid-tight fitting (as listed in Table B-3: Customer-supplied items) into the Bushing Adaptor top cover. Use a sealing gasket to ensure a liquid tight seal.

Note: The Bushing Adaptor thread for the liquid-tight fitting is $\frac{1}{2}$ in. NPSM as illustrated in Figure 5-10.

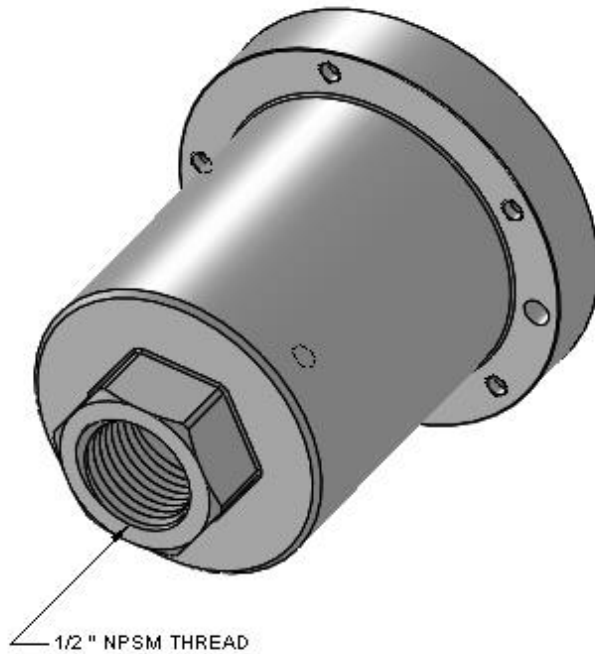

Figure 5-10: Liquid-tight fitting thread

- 5.2.2.11 Thread the end of the metal liquid tight conduit as well as the coaxial cable into the fitting. Terminate the conduit into the fitting carefully to form a liquid-tight assembly.
- 5.2.2.12 Place the O-ring in its seat for the cover (see Figure 5-5).
- 5.2.2.13 Connect the coaxial cable as outlined in Appendix C.4.

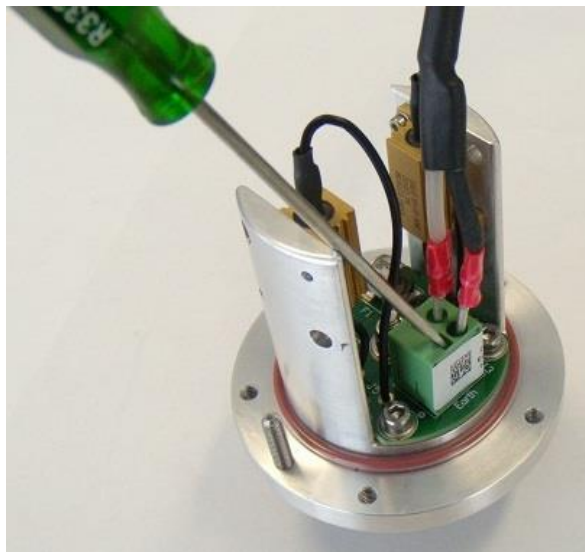

Figure 5-11: Bushing adaptor terminal block



Ensure that there is no tension or stress on the coaxial cable and that there is a loop of cable inside the Bushing Adaptor to allow for strain relief of the coaxial cable.

- 5.2.2.14 Push the top cover down on its seat and re-assemble using the five Allen key screws.
- 5.2.2.15 To compress the sealing O-ring evenly, tighten the five screws progressively working across the circle rather than around the circle of screws as illustrated in Figure 5-12. Tighten the screws to the torque specified in the installation drawing (46-XXXX) provided with each Bushing Adaptor.

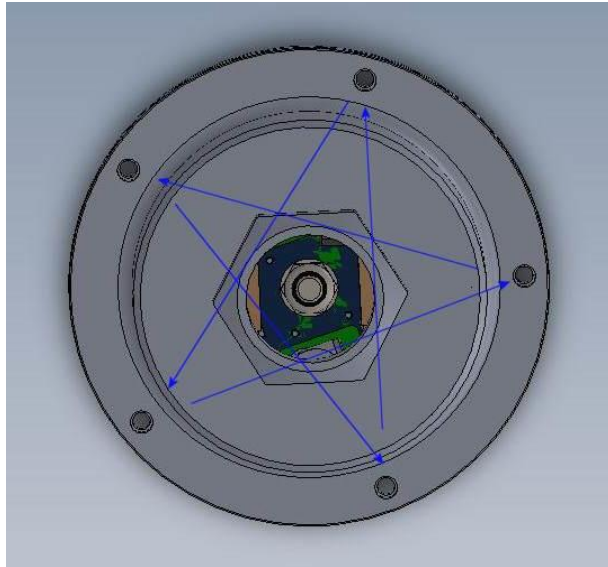

Figure 5-12: Tightening order



WARNING: Ensure that the Bushing Adaptor has been assembled carefully with the liquid tight fitting and conduit to form a liquid tight connection. Water ingress inside the bushing may result in catastrophic failure.

Route all the Bushing Adaptor cables through conduit to the product cabinet. If the cabling is being routed as part of the pre-installation work, then ensure that the phase is properly marked on each coaxial cable.

5.3 High Frequency Current Transformer (HFCT) Connection



WARNING: The HFCT must be installed on a ground cable or bar going from the high voltage neutral bushing (typically identified as H0) directly to ground. There must not be any open switches between the path to ground from the neutral bushing while the transformer is energized.



WARNING: If there is a switch on the path to ground from the high voltage neutral bushing as shown in Figure 5-13, the HFCT must **NOT** be installed between the switch and the neutral bushing, because if for any reason the switch is opened there will no longer be a direct path to ground causing a potentially hazardous condition.



WARNING: Prior to any test that requires the removal of the transformer neutral ground, any installed HFCT must first be removed. Replace the HFCT after the transformer ground has been reconnected.

Preparation of the coaxial cables is outlined in Appendix C.3 and C.6.

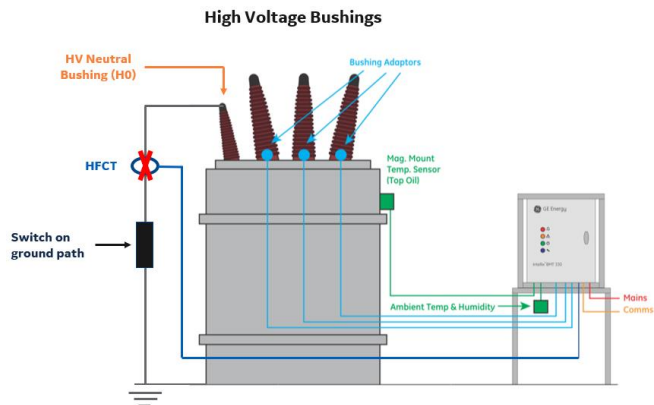

Figure 5-13: HFCT cannot be installed if a switch is on cable from the Neutral Bushing to ground

To minimise noise, the HFCT should be installed as close to the High Voltage Neutral bushing as possible provided there is no switch on the path to ground as per the warning above. Figure 5-14 and Figure 5-15 show the correct installation of the HFCT.

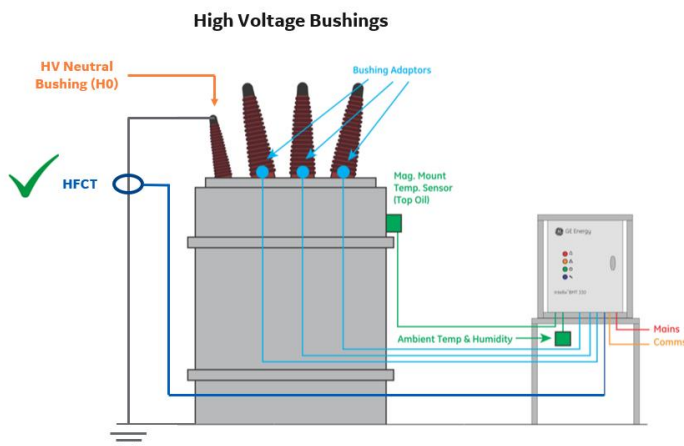

Figure 5-14: HFCT installed on cable from the Neutral Bushing (H0) directly to ground

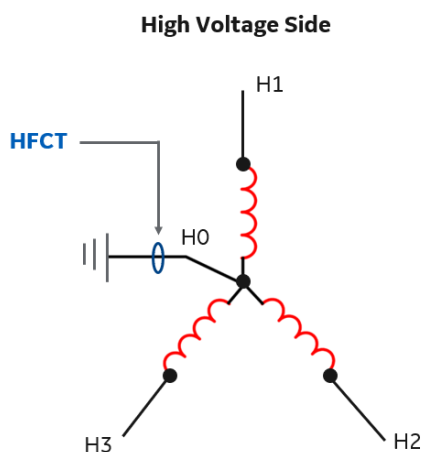

Figure 5-15: Star configuration (Y- Connection)

Similarly, in Figure 5-16, the HFCT can be installed after the switch. However, it should be understood if for any reason the switch is opened, the path to ground will be interrupted and the HFCT will have absolutely no positive affect, resulting in PD diagnostic capabilities being disabled.

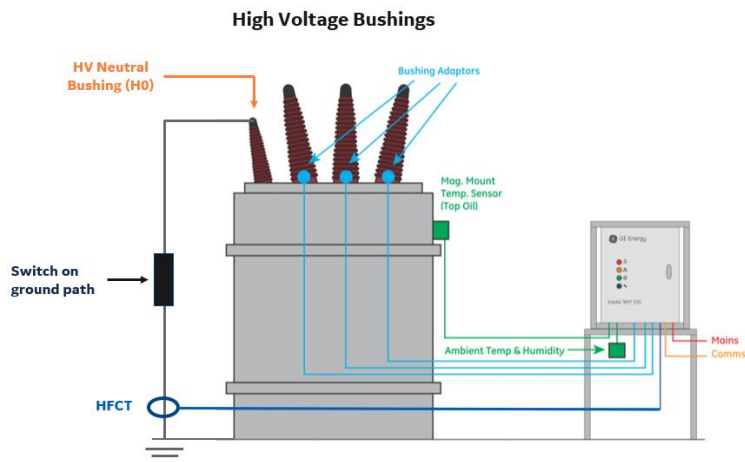

Figure 5-16: HFCT installed after the switch on cable from the Neutral Bushing to ground

The HFCT (if to be fitted) is specific to the transformer connection point (as provided in the pre-installation information). Fit the HFCT clamp to the neutral ground connection as shown in Figure 5-14. An example of the HFCT is shown in Figure 5-17. **Note: The HFCT arrow must point towards earth.**



Figure 5-17: HFCT - example

As with the Bushing Adaptor cables, the HFCT cable should be routed through the conduit to the product cabinet. If the cable routing is carried out as part of a pre-installation activity, mark the cable end to identify it as the appropriate Neutral connection.

5.4 Magnetically-Mounted Temperature Sensors



If working at heights is required during the product installation, it is the responsibility of the installer as a minimum to:

- ensure that planned work complies with national and site regulatory requirements.
- ensure that any third-party equipment to be used is suitable and safe before commencing work.
- ensure that third parties have received appropriate training for working at height. This includes, but is not limited to, 'Working at height' and 'Using Mobile Elevated Working Platforms'.



WARNING: The Thermal Compound and Silicone Safety Data Sheet guidelines must be followed.

The Magnetically-Mounted Temperature Sensor (MMTS) as shown in Figure 5-18 to Figure 5-20 should be attached at the top of the transformer to allow the top oil temperature to be monitored.



Figure 5-18: MMTS rear view



Figure 5-19: MMTS front view



Figure 5-20: MMTS side view - #1

To install the MMTS on a transformer:

- Apply a liberal amount of thermal compound (Wakefield Engineering Thermal Joint Compound 120 series, GE P/N: CONS01026) on the metal probe located in the centre as shown in Figure 5-18. **Note: A lack of thermal compound degrades sensor performance.**
- Apply RTV silicon sealant around the edge of the MMTS. This helps keep out moisture and aids in the adhesion. **Note: No RTV silicon is supplied with the product.**

If installing more than one MMTS, they must be wired in series ensuring that the *last* MMTS on the CANbus line is *MMTS #1*. Keep a record of which MMTS is installed to which single phase transformer so that the product can be commissioned accordingly. See Step 23 in Appendix Table D-1: Results. MMTS #1 has a cable gland, a blanking plug and an internally fitted termination resistance on the PCB between H and L.



At installation, the MMTS should be oriented with the cable gland pointing down as shown in Figure 5-19. This will minimise the risk of water ingress to the sensors.

A 20-metre 4-wire CANbus cable (Belden 8729) is supplied with the product to connect the MMTS (see Appendix B).

Note: Additional cabling may have been purchased.

Route the cable from the MMTS(s) to the product cabinet, cutting as required. Figure 5-21 to Figure 5-22 illustrate the terminal connections inside the MMTS. Figure 5-30 shows the CANbus connection inside the cabinet.

Notes:

- The shield is connected to the ground of the CANbus terminal block (see Figure 5-30).
- It is advisable that the cables are run inside a plastic conduit to provide protection against mechanical damage.
- The cable must be properly inserted into the cable gland. The dome nut of the cable gland must be tightened to a torque of 1.62 N m (14.4 lb in) using a torque wrench.

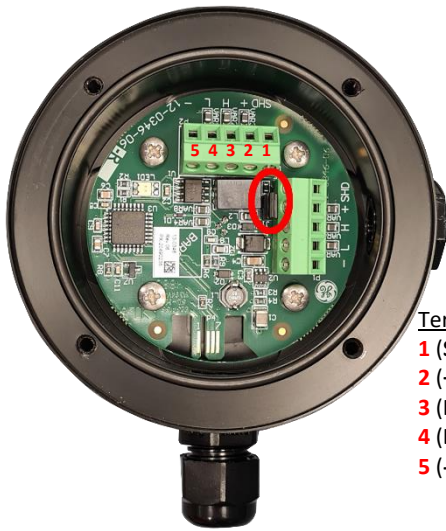

Figure 5-21: MMTS #1 with jumper

Terminal Key

- 1 (SHD)** Shield
- 2 (+)** 12 V DC (red)
- 3 (H)** CANH (green)
- 4 (L)** CANL (white)
- 5 (-)** Ground (black)

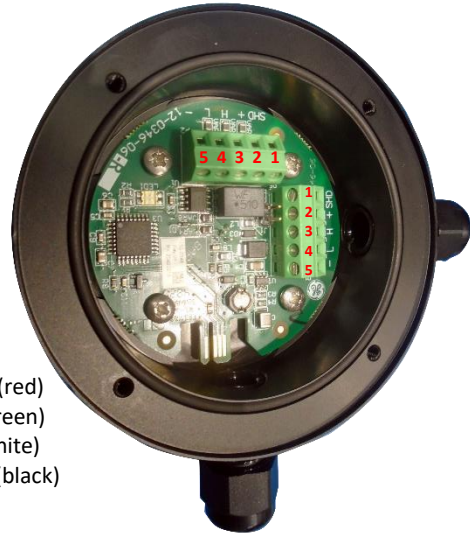

Figure 5-22: MMTS #2/3 without jumper

5.5 Communications Connections

The chosen communication line must be routed to the product cabinet. The RS-485 Modbus must be connected directly to the DIN rail. Alternatively, if fibre optic or armoured Ethernet cable is used, it must be connected to the optional communications module as shown in Figure 5-23. This module supports Ethernet Modbus, DNP 3.0 and IEC 61850 protocols. Fibre optic communication is recommended if the control room is located outside the substation.



Figure 5-23: Fibre optic module

5.6 Cabinet Connections



ALL cables entering the cabinet should have at least 150 mm (6 in.) of excess length to allow for cable strain relief.



WARNING: Do not open the cabinet during rain or snowstorms during the installation process.

5.6.1 Earth

First connect the protective earth conductor to the earth protective conductor terminal, which is adjacent to the fuse holder on the DIN rail.

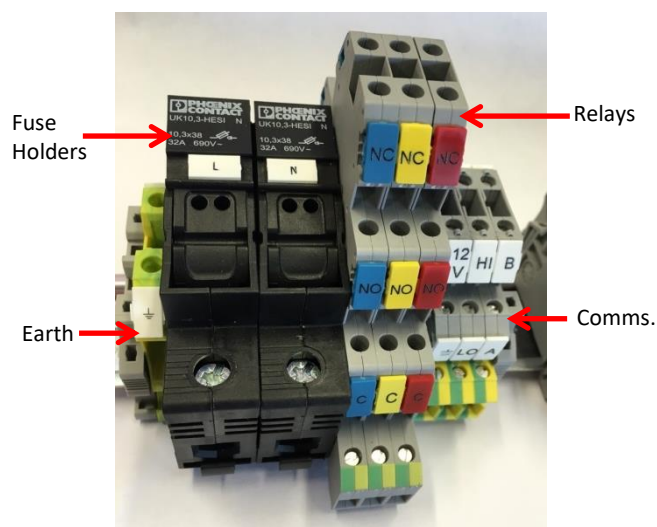

Figure 5-24: Earth adjacent to the fuse holders

The product cabinet has a primary protective earth bonding lug as shown in Figure 5-25 (bottom left-hand side corner when viewed from the front). This bonding lug and the mounting stand *must* be connected to earth in accordance with local practices and safety codes.



Figure 5-25: Position of primary protective earth bonding lug

5.6.2 Ambient Sensor

The ambient temperature and relative humidity sensor is fitted in a raised position for transit as shown in Figure 5-26. Loosen the gland nut and lower the sensor fully as shown in Figure 5-27. Retighten the gland nut.



Figure 5-26: Ambient sensor - raised



Figure 5-27: Ambient sensor - extended

5.6.3 Mains AC



WARNING: Only use cables rated at 75 °C minimum for the installation.



WARNING: An external circuit breaker must be installed on the AC source near to the product and within easy reach of the operator. It should be clearly labelled as the disconnecting device for the product.



WARNING: Fuses and circuit breakers must be installed in accordance with the local and/or national wiring regulations.



WARNING: The outer sheath of the mains supply cable should continue into the equipment as far as possible so that reinforced insulation is maintained between the operator and mains supply.



WARNING: The mains supply should be connected so that the protective earth wire should be the last wire to take the strain and break free in the event of the cord being pulled out of the cabinet. Tighten the cable gland to secure the cable.

Ensure that the mains AC supply is de-energised. Connect the mains AC supply cable through the left-most cable gland of the cabinet to the product fuse holder (see Figure 5-24).

Note: Refer to the local/national wiring requirements to determine the gauge and length for the power supply wiring.

5.6.4 Bushing Adaptors & HFCT(s)



Before connecting the Bushing Adaptor coaxial cables to the product cabinet, test that the ground connections have been made correctly. Verify that there is continuity from the shield of each of the Bushing Adaptor cables to the product cabinet ground terminal.



An external circuit breaker must be installed on the AC source near the product and within easy reach of the operator. It should be clearly labelled as the disconnecting device for the product.

An overview of the Bushing Adaptor connections is shown in Figure 5-28. The input terminals for the coaxial cable connections are identified as S1, S2, S3, P1, P2, P3, N1, N2, N3 (Core and Shield). See Section 4.5 Bushing Adaptor Cable Runs.

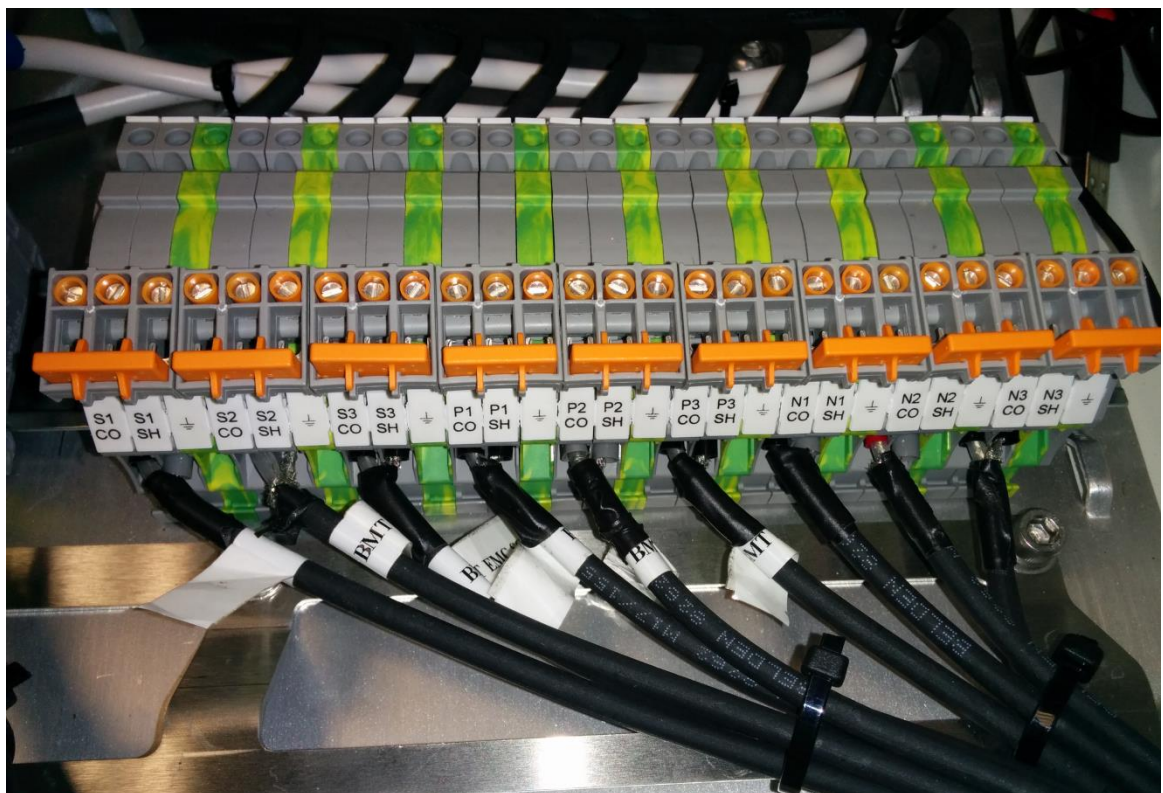

Figure 5-28: Bushing adaptor connections



WARNING: The *rated maximum working* voltage that may be present on each phase is 5 V AC rms and the *rated maximum current* that may be present is 200 mA. The measurement category is CAT III for circuits that can be connected to any coaxial cable connection.

The interconnecting coaxial cables between the grounding switches and the main board are installed in the factory as shown in Figure 5-29. The order of the board inputs is from left to right as follows:

- Three Secondary Bushing Adaptor inputs: phases S1, S2 and S3.
- Three Primary Bushing Adaptor inputs: phases P1, P2 and P3.
- Neutrals N1, N2 and N3.

For each input the coaxial central wire is connected to the core (CO) on the left and the shield (SH) on the right as shown in Figure 5-29.

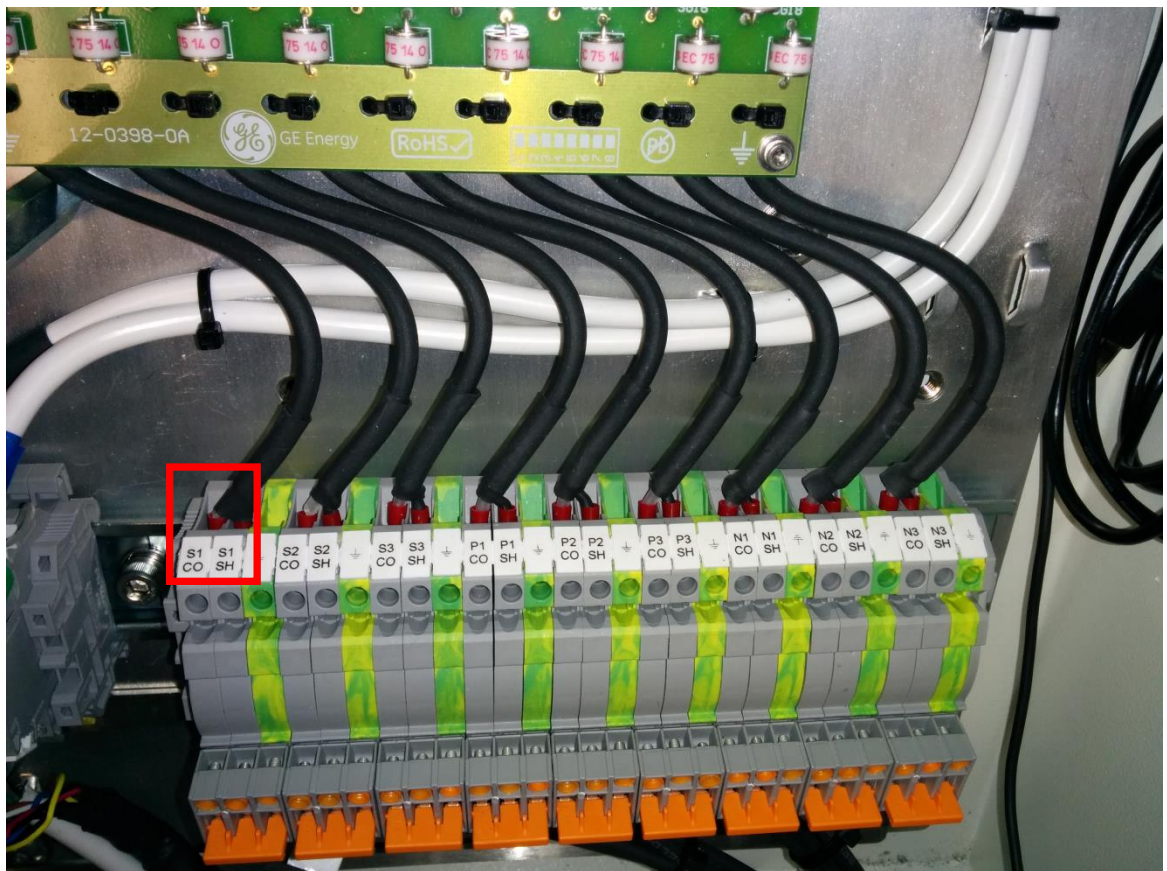

Figure 5-29: PCB phase inputs - Secondary (left), Primary (middle) & Neutral CT (right)

For connection of the Bushing Adaptors as well as the HFCT(s) to the grounding switch terminals, see Appendix C.5 and C.6.

5.6.5 Magnetically-Mounted Temperature Sensors

The MMTS is connected to the CANbus connectors on the DIN rail. See Figure 5-4 for an overview to the key parts of the product and Figure 5-30 below for a more detailed look at the connection points.

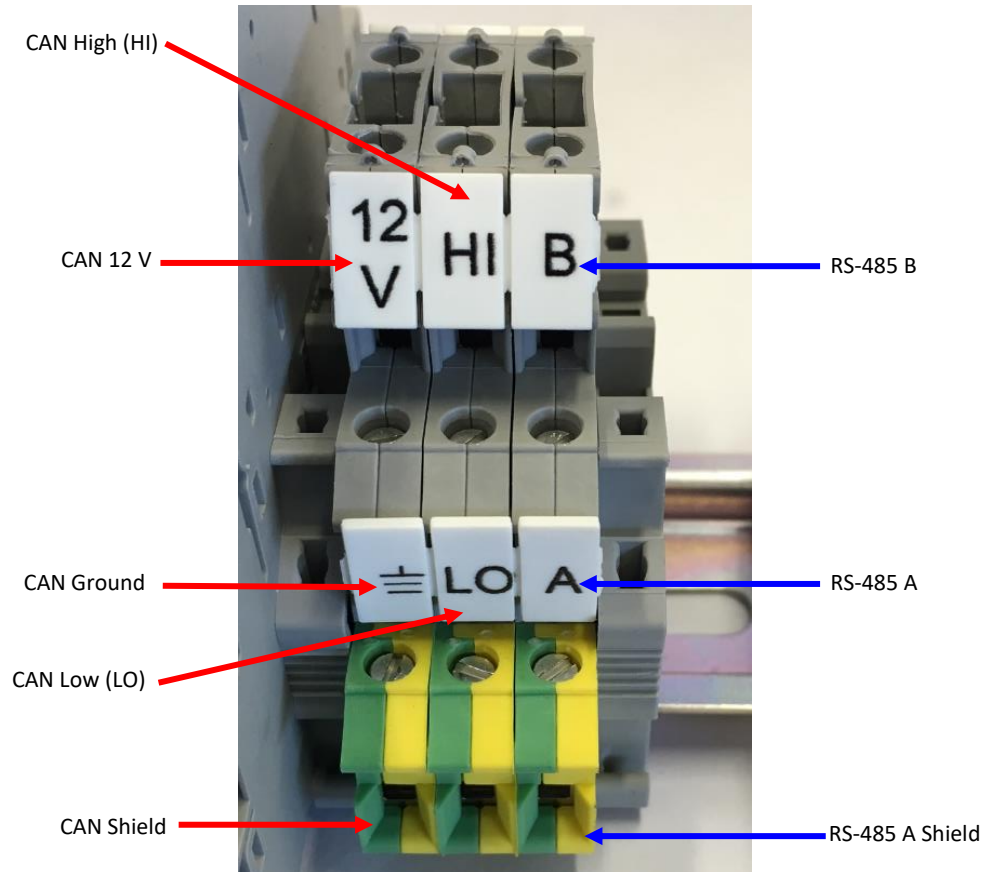

Figure 5-30: CANbus Connection on the DIN rail

Due to the inability to reach the MMTS(s) once the transformer is energised, communication with the sensor must be tested before the transformer is switched on (if power to the product is available). Refer to the 'Measurement' section of the Intellix™ BMT 330 User Manual and check that the Field Sensors Error for Top Oil is not increasing by 1 every second and that the respective temperatures in the Field Sensors are within the expected range.

5.6.6 Communications

5.6.6.1 RS-485 Modbus (standard)

The standard RS-485 connection is routed to the DIN rail from the main PCB as shown in Figure 5-30.

5.6.6.2 Copper Ethernet (optional)

Copper Ethernet supports the Modbus protocol with DNP 3.0 or IEC 61850. With this equipment, only shielded cable should be used to meet the required EMC standards. If an optional communication channel has been specified, there will be an extra module on the Intellix™ BMT 330 motherboard as shown in Figure 5-31. This module supports MultiMaster communications.

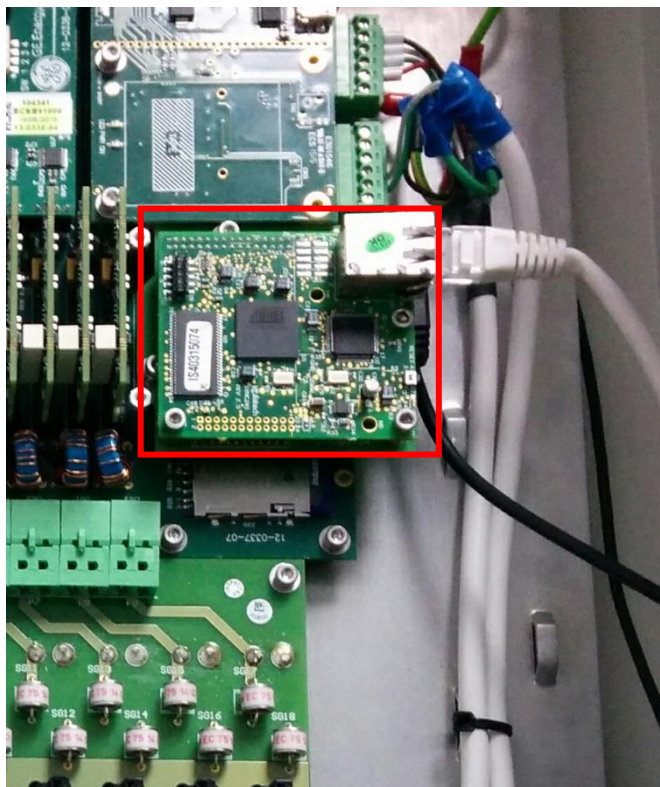

Figure 5-31: Copper Ethernet

For more details on how to configure the optional communication module, see Appendix E.

The copper-based channel requires a cat 5e Ethernet cable and a clamp-on ferrite (included in the Installation kit, see Appendix B). This cable must enter the cabinet through one of the available cable glands and must be routed to the communication module. The ferrite must be added to the Ethernet cable with 3 loops (4 passes) inside the cabinet close to where the cable exits the cabinet.

5.6.6.3 Fibre Optic Ethernet

Fibre optic Ethernet supports the Modbus protocol with DNP 3.0 or IEC 61850. If an optional communication channel has been specified, then there will be an extra module on the Intellix™ BMT 330 motherboard as shown in Figure 5-32. This module supports MultiMaster communications.

- Recommended Multimode Fiber Optic cable be used
- Connection to the Fiber Optic module in the BMT 330 is ST type
- Fiber Optic module is a 100BaseFX (100 Mbps)



Figure 5-32: Fibre optic module

For more details on how to configure the optional communication module, see Appendix E.

If the chosen physical layer is fibre optic, then the module can be connected to a converter of the customer's choice. Use the following procedure for proper connection (even where a converter is not used):

To connect to the Intellix™ BMT 330 serial fibre optic module as shown in Figure 5-33, the cable must enter the cabinet through one of the available cable glands and be routed to the communication module as follows:

- The fibre optic cable coming from the host fibre optic Tx connector should go to the Rx connector of the Intellix™ BMT 330 serial fibre optic module.
- Then connect the fibre optic wire coming from the Rx connector of the host fibre optic module to the Tx connector of the Intellix™ BMT 330 serial fibre optic module. See Figure 5-33 below.



LED transmitters for fibre optics are classified as IEC 60825-1 Accessible Emission Limit (AEL) Class 1. Class 1 devices are eye-safe to the unaided eye. Do not view directly with optical instruments. Laser radiation. Do not view directly with optical instruments.

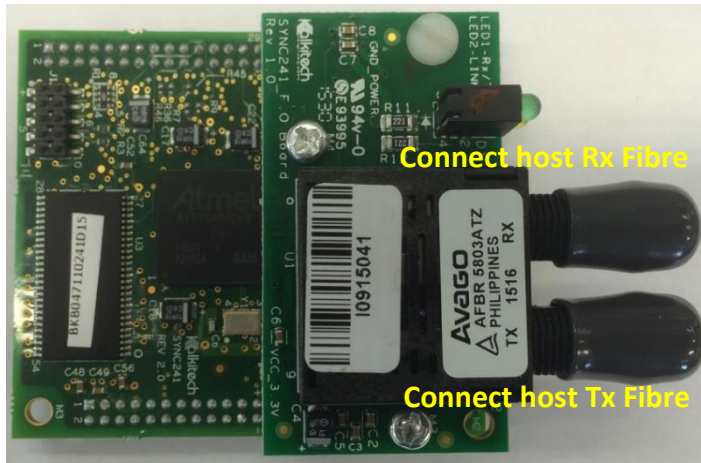

Figure 5-33: Fibre optic connections

5.6.7 GPS Antenna

The Intellix™ BMT 330 has a built-in GPS chip, which is used to provide a date/time stamp to the event monitoring. The supplied GPS antenna has a magnetic mounting. Place the GPS antenna in a position where it has a clear view of the sky. Route the antenna cable into the product cabinet via one of the cable gland entries. The antenna cable should be connected to the dedicated point at the top right hand of the PCB as shown in Figure 5-34.

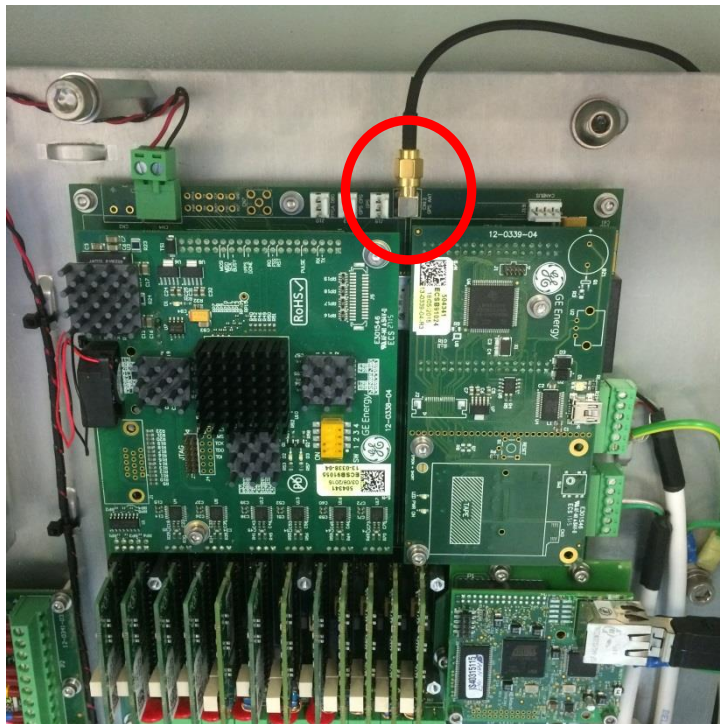

Figure 5-34: GPS antenna connection point

The following points must be considered in choosing the location of the GPS antenna:

- The antenna must have a clear line-of-sight of a significant portion of the sky so that GPS satellite signals can be received.
- The antenna is magnetically mounted so a suitable ferromagnetic surface must be found. This ferromagnetic surface must be grounded.

- If the product cabinet is installed at a location with a clear view of the sky, the antenna can be installed on the exterior of the cabinet. A ferromagnetic plate is welded towards the top-right interior corner of the cabinet to allow the GPS antenna to be magnetically mounted externally at this position as shown in Figure 5-35.
- Although the antenna does not increase the likelihood of a lightning strike, the surface itself must not be part of a structure that might potentially become a lightning conductor.
- The GPS antenna is supplied with a 5 m (16.4 ft) cable.

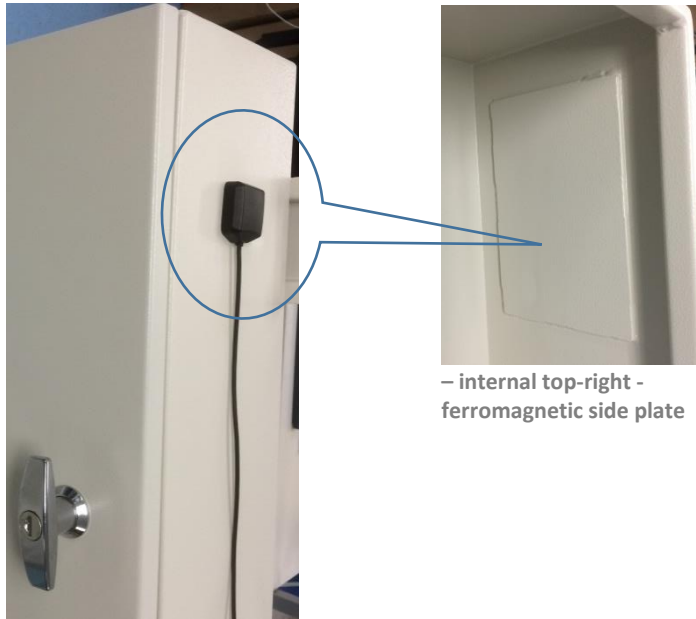

Figure 5-35: Cabinet - external top right - GPS antenna

If no suitable place is found (and no GPS antenna has been installed) or the GPS signal is lost during operation, the product will use an internal clock to time stamp events and data. This clock is continuously synchronised with the GPS time when available. If no GPS is available at power up, the product will use the time stamp of the most recent event or data to use as the current time. As soon as the GPS is available, the product will synchronise back to the GPS time. If communication is established with the product and no GPS synchronisation has occurred, the user must synchronise the Intellix™ BMT 330 time to the PC's time. The time will be lost if the product is switched off. Refer to the 'Device Information' section in the Intellix™ BMT 330 User Manual.

5.6.8 Alarm relays

Three alarm relays are provided on a small PCB as shown schematically in Figure 5-36 and are wired to connector blocks on the DIN rail as shown in Figure 5-37.

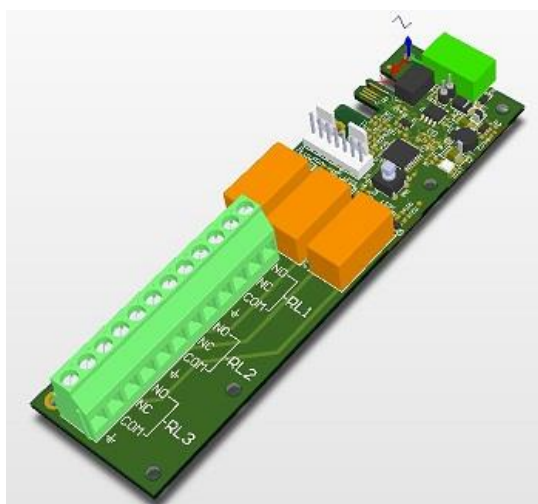

Figure 5-36: Relay board (schematic)

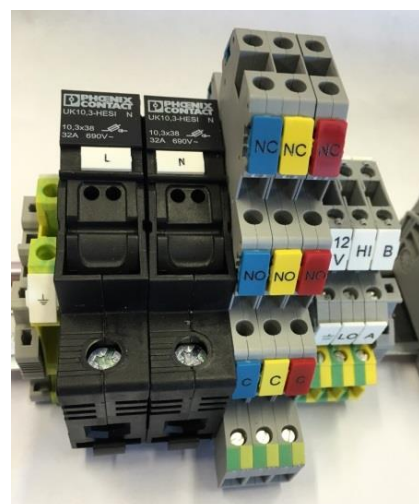

Figure 5-37: Relay connections (right) and Mains (left)

These relays can be used to drive a hardware alarm e.g. control room light, klaxon etc. The precise alarm conditions to activate each of the relays is configured using the Intellix™ BMT 330 Setup Software.

The maximum drive capacity of each relay is:

2 A @ 240 V AC, resistive load, or

2 A @ 30 V DC.

If connecting external alarms to these relays, route the cables through one of the available cable glands.



WARNING: Only use cables rated at 75 °C minimum for the installation.

The pin-out from top to bottom is listed in Table 5-1.

Table 5-1: Relay connections

Relay #	Symbol	Purpose
1 SERVICE	NO	Normally Open
	NC	Normally Closed
	C	Common
	Green/Yellow terminal	Ground
2 WARNING	NO	Normally Open
	NC	Normally Closed
	C	Common
	Green/Yellow terminal	Ground
3 ALARM	NO	Normally Open
	NC	Normally Closed
	C	Common
	Green/Yellow terminal	Ground

5.7 Configuration and commissioning

Once all connections are made, the product must be configured using the companion Intellix™ BMT 330 Setup Software. Refer to the Intellix™ BMT 330 User Manual for the software installation, and for commissioning information refer to the Intellix™ BMT 330 Commissioning Instructions.

5.8 Decommissioning

Before decommissioning ensure that the original bushing test tap caps are available and in good condition.



WARNING: Follow the steps in the order below ensuring that the transformer and all AC supplies (including any relay connection) to the product cabinet are de-energised before commencing the decommissioning. Follow LOTO procedures.



WARNING: Do not open the product cabinet during rain or snowstorms.

Before decommissioning, download the latest data if required (data can also be retrieved later since it is internally stored on an SD card).



The SD card should only be retrieved by an approved engineer — under no circumstances should it be inserted into a PC as that would risk accidental reformatting and subsequently data loss.

Perform the following steps to decommission the product:

1. De-energise and switch off the transformer; ground the transformer main leads and apply LOTO.
2. Remove power from the AC supply to the product and apply LOTO procedures.
3. Remove power from the relay supplies that are controlled by the product and apply LOTO procedures.
4. Open the product cabinet.
5. Remove the AC supply cable from the fuse holders (see Figure 5-24).
6. Remove the relay control cables from the relay board (see Figure 5-37).
7. Replace the product Bushing Adaptors with the original tap covers.



WARNING Failure to replace the original test tap caps may cause catastrophic failure of the bushing.

8. Remove cabling and external sensors (MMTS, GPS antenna and HFCT).
9. Remove the cabinet and stand.
10. Re-energise the transformer.

Figure A-1 to Figure A-4 below show the dimensioned drawings of the Intellix™ BMT 330 stand and sun hood. These are for illustration purposes only. If pre-installation work depends upon the stand dimensions, request the current issue of these drawings before commencing any work.

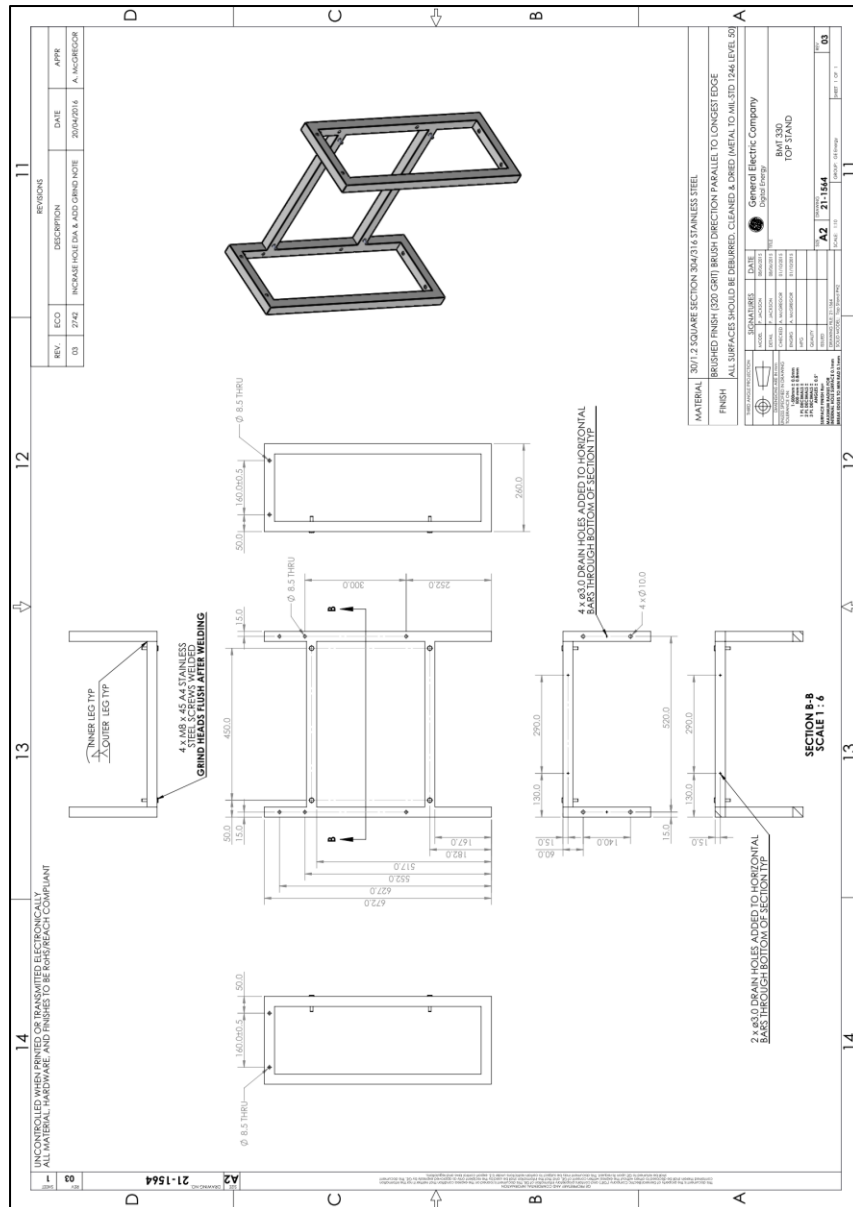

Figure A-1: Upper (or transport) stand

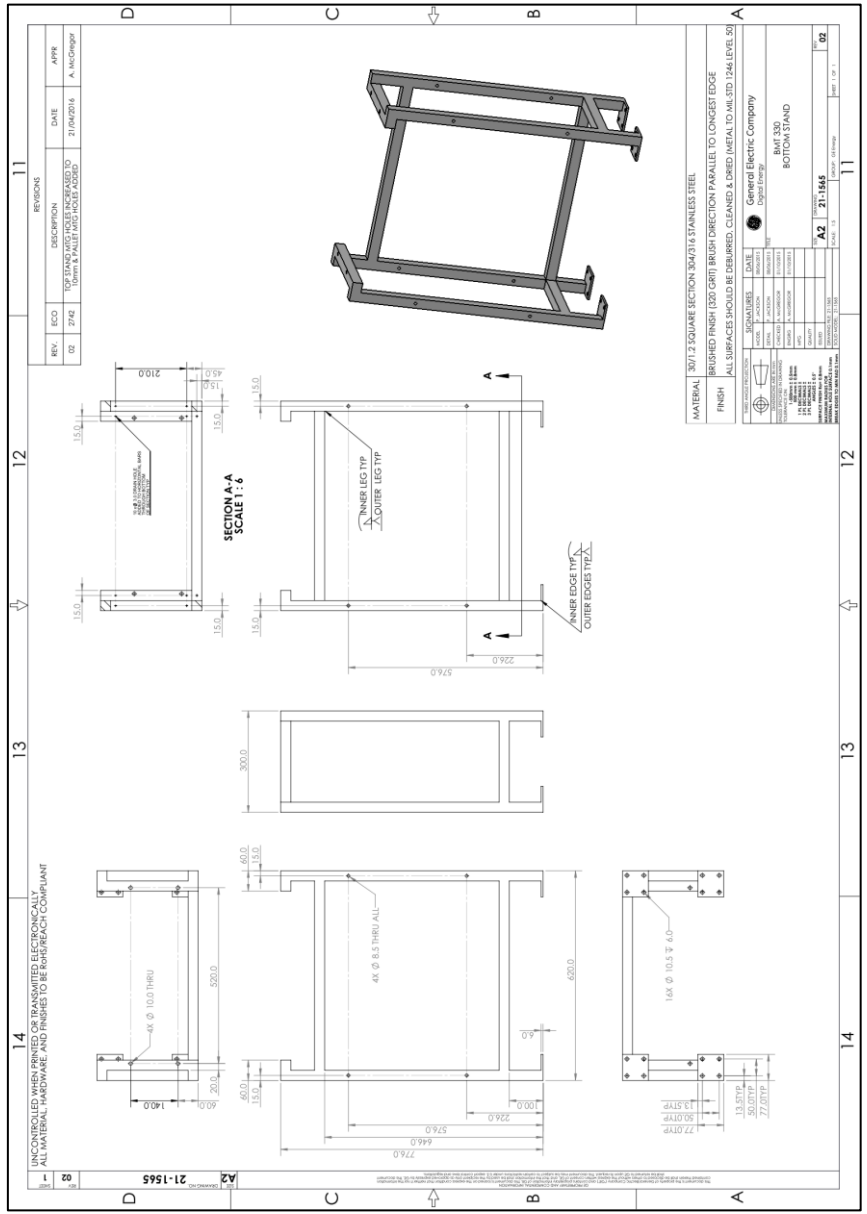

Figure A-2: Lower stand

Note: Each foot on the base stand has three available mounting holes (of which only one hole is required).

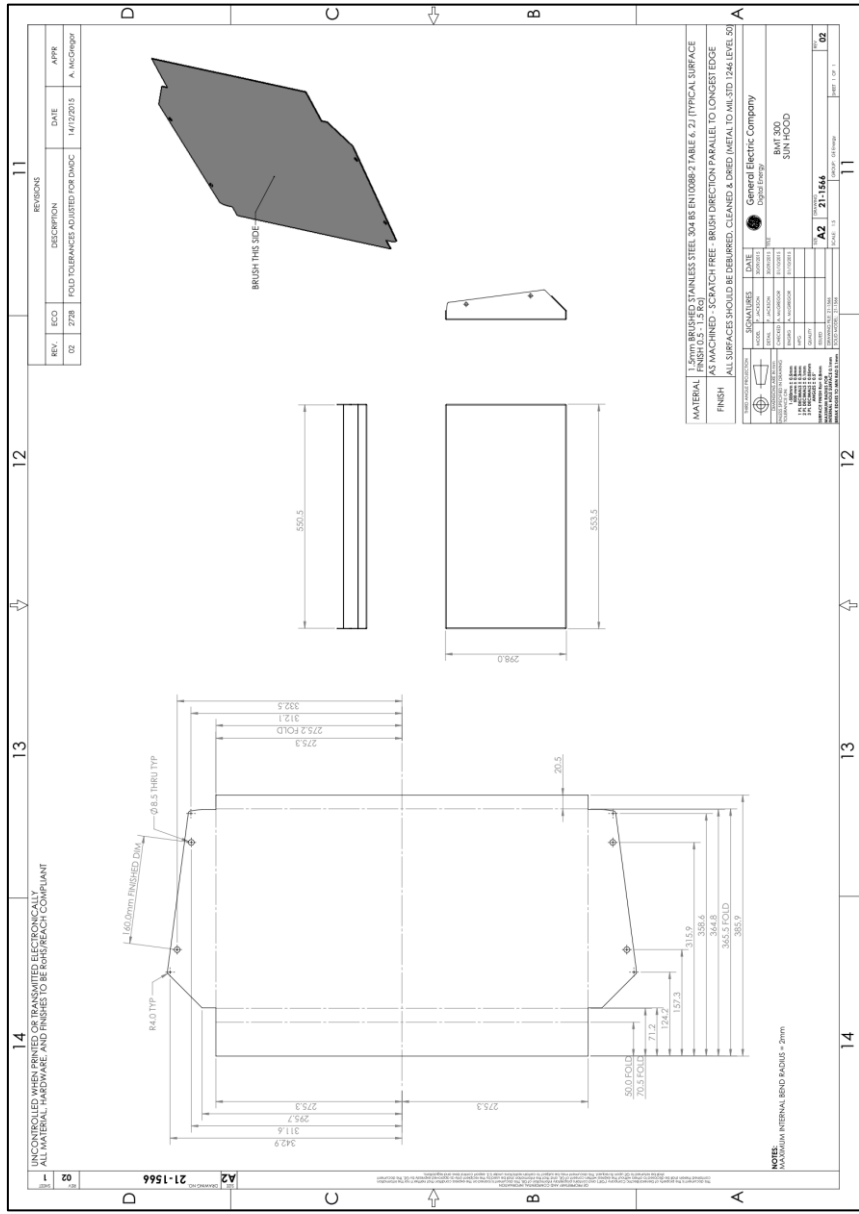

Figure A-3: Sun hood

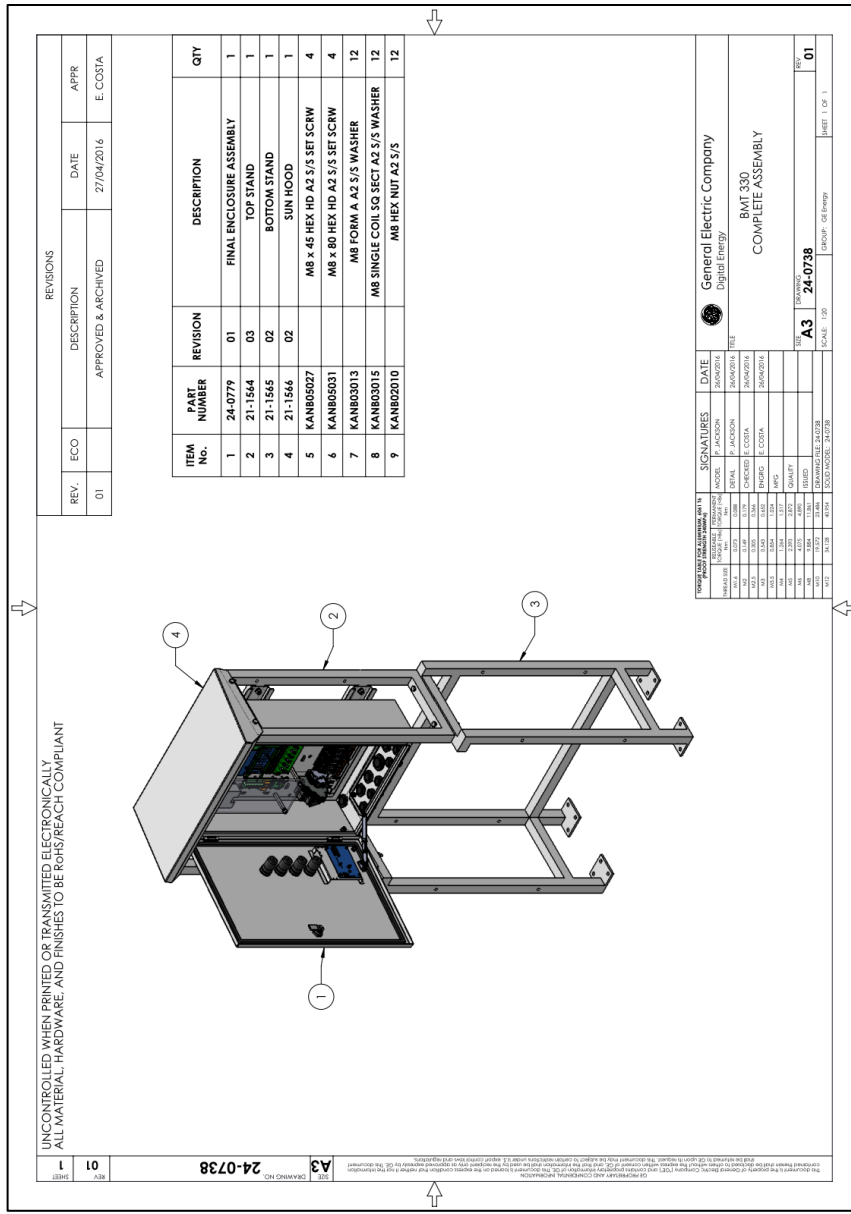





Figure A-4: Intellix™ BMT 330 with stand and sun hood attached



The parts, supplies and tools for a product installation are listed in tables Table B-1 to Table B-3 and are needed on site at the time of the installation.

Note: Confirm with GE Technical Support as lubricants and quantities are subject to change without prior notice.

B.1 GE-supplied items (shipped with the product)

Table B-1: GE-supplied items

Qty	Description
Standard Items	
1	Intellix™ BMT 330 (Bushing & PD Monitor)
3	Primary Bushing Adaptors (for basic installation)
3	Secondary Bushing Adaptors (optional for full installation) Note: Each Bushing Adaptor is supplied with a full set of O-rings (and one spare set)
Up to 4	High Frequency CT (optional)
Up to 4	Magnetically-Mounted Temperature Sensors (MMTS)
1	Ambient temperature and relative humidity sensor
1	Base stand (optional)
1	GPS antenna (supplied with 5 m cable)
Installation Kit	
1	Optional: RG58C/U 50 Ω coaxial cable (Belden P/N: 8262) to connect the Bushing Adaptor and Neutral CT to the product. Length to be determined from the pre-installation information (GE P/N = CABL02048). 
1	4-wire CANbus cable (Belden 8729) (20 m long) to connect the MMTS to the product. Additional cable must be ordered or sourced when single phase transformers are being monitored (GE P/N = CABL02053).
Hardware for coaxial cables connection:	
15	<ul style="list-style-type: none"> Red pin terminals 18-22 AWG (Molex 19213-0009) 
1	<ul style="list-style-type: none"> Heat shrink 3/16 in. tubing 60 mm (2.4 in) 

Qty	Description
1	<ul style="list-style-type: none"> Heat shrink ¼ in. tubing 60 mm (2.4 in) 
6 of each (N x8)	Cable markers P, S, N, 1, 2, 3 and 4 
1	P/N: CONS01149 - MG Carbon Electrically Conductive Grease 846
1	Thermal jointing compound (Wakefield Engineering, 120 series) (GE P/N: CONS01026)
1	Ethernet cable Ferrite (Würth 7427 154) when optional copper Ethernet module is ordered (GE P/N: ELECO4004)
>	One spare O-ring for each bushing adaptor is supplied

B.2 GE Field Service Engineer (FSE)-supplied items

If GE performs the installation, the GE FSE will bring the following items:

Table B-2: GE FSE-supplied items

Qty	Description
1	Handheld multimeter 4½ digit with: <ul style="list-style-type: none"> Testing continuity capability AC voltage measurement (0.5%) Resistance measurement (0.5%) (Suggested model: Fluke 87 or 287 or equivalent).
>	Required material as described in 'Appendix D - Bushing Adaptor Circuit Integrity Test Record' of the Intellix BMT 330 Installation Manual.
1	27 mm socket to fit ½ in. square drive torque wrench
1	½ in. square drive torque wrench with a capable range of 10 - 100 Nm (7 - 73 lb ft)
1	1.25 N m torque screwdriver
1	3 mm ball hex blade for torque screwdriver
1	Ratchet crimp tool.

B.3 Customer-supplied Items

The following items are procured by the customer:

Table B-3: Customer-supplied items

Qty	Description
1	Armoured mains cable to power the product.
1	Grounding cable to connect primary protective earth terminal lug of the product cabinet to the ground.

Qty	Description
>	Liquid-tight flexible metal conduit (½ in. and/or ¾ in.) to provide protection for the Bushing Adaptors' cables and Neutral CT cable (working temperature range: -55 °C to 105 °C recommended). Recommended models from Thomas & Betts: <ul style="list-style-type: none"> ▪ Metal conduit ½ in. liquid-tight, Model ATLA050-30 (30 m) ▪ Metal conduit ½ in. liquid-tight, Model ATLA050-150 (150 m) ▪ Metal conduit ½ in. liquid-tight, Model ATLA050-300 (300 m)
>	Liquid-tight metal fittings and gaskets for the Bushing Adaptor. Recommended model from Thomas & Betts: <ul style="list-style-type: none"> ▪ Liquid-tight fittings, Model 5332-HT ▪ Sealing gasket ½ in., Model 5262
>	Plastic conduit in sufficient length to provide protection for the temperature sensor cables (optional).
>	Cable trays and cable ties to run the cables.
1	RTV (Room Temperature Vulcanisation: silicon-based mastic), 3M Super Silicone Sealant No. 8663 or equivalent for the MMTS.
1	Heat gun (for heat shrink)
>	General tools (drill, drill bits, screwdrivers, cutter and spanners)

Follow these steps to connect the coaxial cables:

C.1 Routing the Coaxial Cables











1. Route the coaxial cables through the metal conduits from each Bushing Adaptor to the product cabinet as required.
2. On the cabinet side, the coaxial cables must be routed through the connector fittings at the bottom of the cabinet. Each cable can be up to 100 m and must be identified with cable markers.
3. All the coaxial cables must be connected to the Bushing Adaptor on one end and to the grounding switch inside the cabinet on the other end.

C.2 Required Materials & Tools

Identify the materials listed in Table C-1 for connecting the coaxial cables to the Bushing Adaptors and to the shorting switch.

Note: All these materials are shipped with the product.

Table C-1: Required materials

Coaxial cable RG-58C/U 150m (500ft)							
Red pin terminals							
Qty	15						
Heat shrink $\frac{3}{16}$ in. tubing 60 mm (2.4 in.) Heat shrink $\frac{1}{4}$ in. tubing 60 mm (2.4 in.)							
Cable markers							
Qty	6	6	8	6	6	6	6

The following tool as shown in Table C-2 is supplied by the customer and is recommended for preparing the coaxial cables.







Table C-2: Required tools

Heat gun	
----------	---

C.3 Coaxial Cables Preparation

Note: Each coaxial cable must be prepared on both ends (Bushing Adaptor and cabinet) as follows.

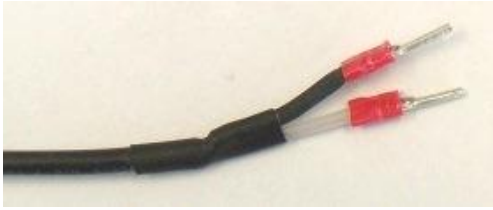
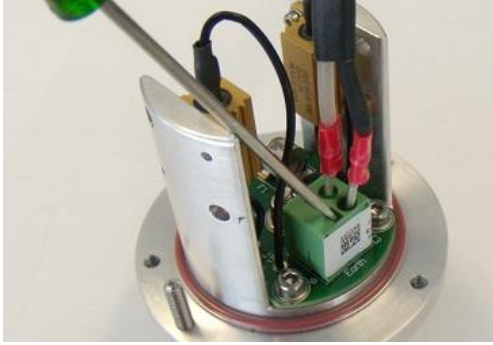

Table C-3: Coaxial cables preparation

Steps	Visual
<ol style="list-style-type: none"> 1. Cut the $\frac{3}{16}$ in. heat shrink tubing into pieces approximately 30 mm (1 $\frac{1}{4}$ in.) long. 2. Cut the $\frac{1}{4}$ in. heat shrink tubing into pieces approximately 30 mm (1 $\frac{1}{4}$ in.) long. 	
<ol style="list-style-type: none"> 3. Remove approximately 40 mm (1 $\frac{1}{2}$ in.) of the outer jacket from the coaxial cable taking care not to cut the metallic braid. 	
<ol style="list-style-type: none"> 4. Un-strand the metallic braid shield and twist it together. 	
<ol style="list-style-type: none"> 5. First insert the $\frac{1}{4}$ in. tubing through the central conductor and shield. 6. Then insert the $\frac{3}{16}$ in. tubing through the metallic braid. 	
<ol style="list-style-type: none"> 7. Use a heat gun to shrink the $\frac{3}{16}$ in. tubing. 	
<ol style="list-style-type: none"> 8. Then, insert the $\frac{1}{4}$ in. tubing to overlap about 15 mm (0.6 in.) over the metallic braid. 9. Use a heat gun to shrink the $\frac{1}{4}$ in. tubing. 10. Strip away about 7 mm ($\frac{1}{4}$ in.) of insulation from the central conductor. Twist the strands together. 	

C.4 Connecting to the Bushing Adaptor

Note: At the Bushing Adaptor end, the coaxial cables must be terminated with two pin terminals.

Table C-4: Connecting to the Bushing Adaptor

Steps	Visual
<ol style="list-style-type: none"> 1. Select two red pin terminals and the corresponding hand crimp tool. 	
<ol style="list-style-type: none"> 2. Insert the central conductor of the coaxial cable into one pin terminal and crimp that terminal. 3. Insert the braid shield into the second pin terminal and crimp that terminal. 4. The terminals must be double crimped (once on the bare wire and once on the insulation). Verify visually and by a pull test on the terminals. 	
<ol style="list-style-type: none"> 5. Insert the coaxial cable through the connector fitting of the Bushing Adaptor cover. 6. Connect the wires to connector J3 of the Bushing Adaptor board. 7. J3 is a spring-cage type connector. Open the terminal point with a small flat screw driver. 8. The central white wire must be inserted into the <i>inner</i> terminal. 9. The braid shield must be inserted into the <i>outer</i> terminal. 	
<ol style="list-style-type: none"> 10. A fully connected Bushing Adaptor is shown. 	

C.5 Connecting to the Grounding Switch

Note: At the cabinet end, repeat the steps 1-4 in Section C.4 above and use the same pins to terminate the cable.

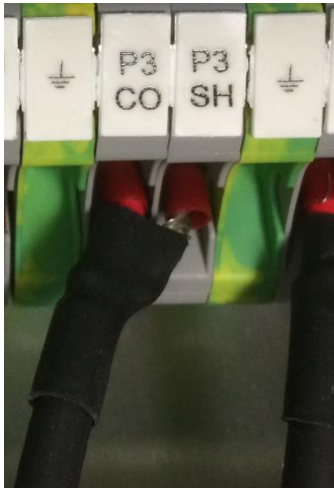

Table C-5: Connecting to the grounding switch





Steps	Visual
<ol style="list-style-type: none"> 1. The central white wire must be connected to the <i>core</i> connector. 2. The braid shield must be connected to the <i>shield</i> connector. 	
<ol style="list-style-type: none"> 3. Repeat these steps for all input phases for the Bushing Adaptors and the Neutral CT(s). 	

C.6 Connecting to the Neutral CT

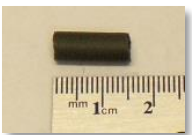
Note: At the Neutral CT end, the coaxial cable does not require terminals.

Table C-6: Connecting to the Neutral CT

Steps	Visual
<ol style="list-style-type: none"> 1. Remove approximately 25 mm (1 in.) of the outer jacket from the coaxial cable (taking care not to cut the metallic braid). 	
<ol style="list-style-type: none"> 2. Un-strand the metallic braid shield and twist it together. 	
<ol style="list-style-type: none"> 3. Select one piece of heat shrink tubing $\frac{3}{16}$ in., about 15 mm (5/8 in.) long. 	

<ol style="list-style-type: none"> 4. Insert the tubing through the metallic braid and heat shrink the tubing. 5. Strip away about 7 mm (¼ in.) of insulation from the central conductor. Twist the strands together. 	
<ol style="list-style-type: none"> 6. Remove the connector fitting from the CT. 7. Insert the dome nut, fitting body and seal ring through the coaxial cable as shown. 	
<ol style="list-style-type: none"> 8. Connect the cable to the terminals of the CT. 9. The central white wire must be connected to the <i>core</i> side. 10. The braid shield must be connected to the <i>shield</i> side. 11. Tighten the set screws using a hex key wrench (1.5 mm). 	
<ol style="list-style-type: none"> 12. Screw the fitting body into the HFCT with the seal ring. Hold the wire to prevent it from twisting. Recommended torque is 3.75 N m (33 lb in). 13. Screw the dome nut tightly into place. Recommended torque is 2.50 N m (22 lb in). 14. The fitting and the nut must be tightened properly to prevent water ingress. 	

The Bushing Adaptor Circuit Integrity Test is to be performed upon installation, after periodic transformer maintenance or any bushing repair activities.

D.1 Required Material

- Antenna Analyser, RigExpert (model: AA-170)
- UHF to BNC adaptor
- Coax cable with BNC connector at one end and clips at the other end as shown in Figure D-1



Figure D-1: Coax BNC to clips cable

- Two small flat screwdrivers or a 2-pin connector and a release key as shown in Figure D-2



Figure D-2: 2-pin connector and release key

- USB cable with type B connector
- PC with AntScope software installed
- 50 W wire-through resistor
- Ohmmeter

D.2 Test Procedure

The RigExpert AA-170 handheld antenna analyser is used to verify the electrical connection of the internal Bushing Adaptor. Before commencing the test:



Ensure that the transformer is switched off and properly grounded. The Intellix™ BMT 330 shall not be energised.



The grounding switches for the coaxial cables in the product cabinet are to be set to 'not grounded' (operational position).



Disconnect ALL the coaxial cables as shown in Figure D-3.

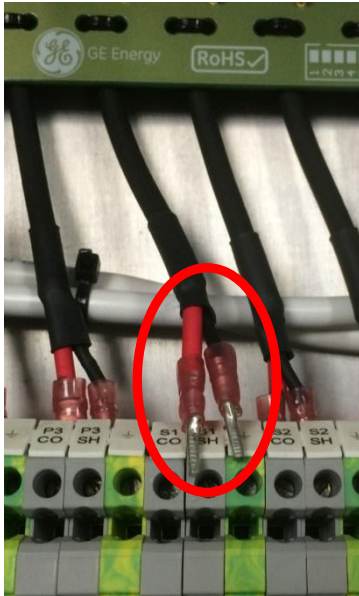

Figure D-3: Disconnection of coaxial cables

Follow these steps to calibrate the AA-170.

Note: The calibration considers the waveguide between the measuring circuit and the load i.e. adaptor + cable + cable position.

Note: It is important to keep the cable straight between the AA-170 and the Bushing Adaptor during all the measurements.

1. Create a new folder on the computer. Next create a subfolder for each Bushing Adaptor using its corresponding serial number as the name.

Note: These folders are used to save the data measured by the AA-170.

2. Connect the AA-170 to the PC via the USB cable.
3. Power on the AA-170.
4. Open the AntScope software.

- Set the COM port assigned to the AA-170 as shown in Figure D-4.

Note: To verify that this COM port is the one assigned to AA-170, check the vendor id (VID=0403) and product id (PID=6001).

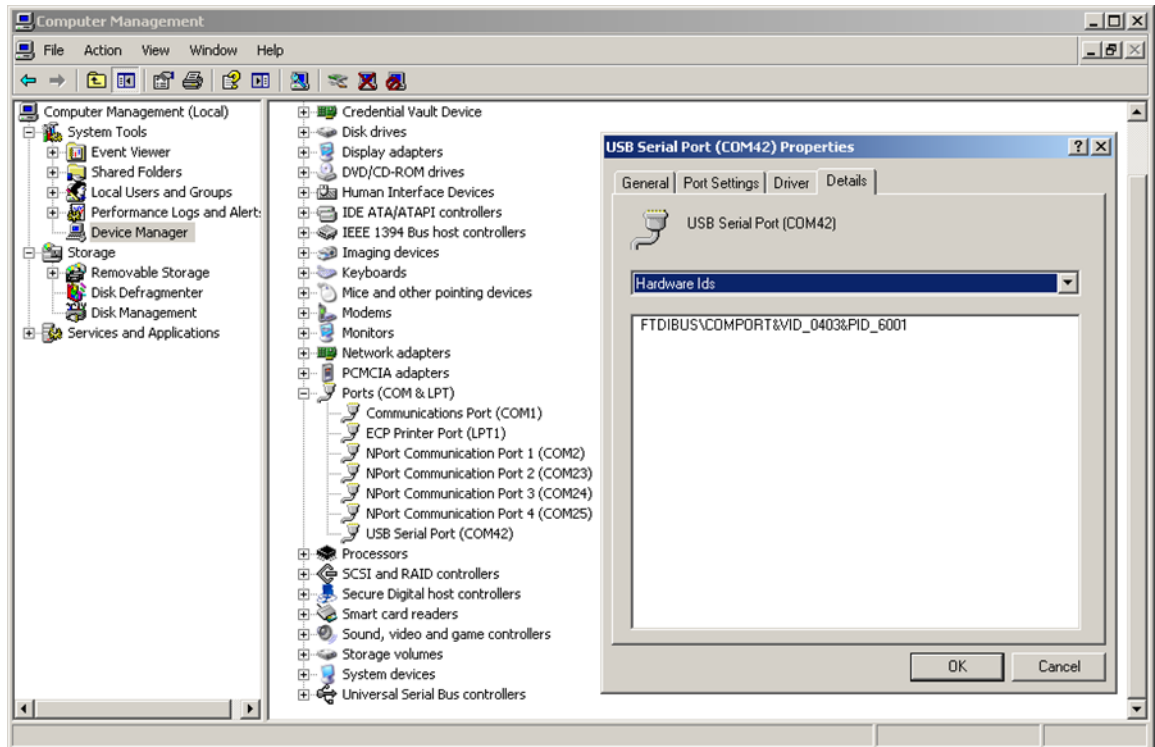

Figure D-4: AA-170 - USB serial port

- Select the AA-170 as the antenna analyser model in the AntScope software (select **Configure** and then **AA-170**).
- Place the coaxial cable so that during the calibration and the subsequent measurements minimal movement of the cable will occur. Leave the clips unconnected, i.e. open circuit, as shown in Figure D-8).
- Select **Action > Scan** to configure the resolution and scanning range. Type 100 points for the resolution, click the **Set full range** button (or press **F9**) and click **OK** as shown in Figure D-5. A measurement will be triggered.

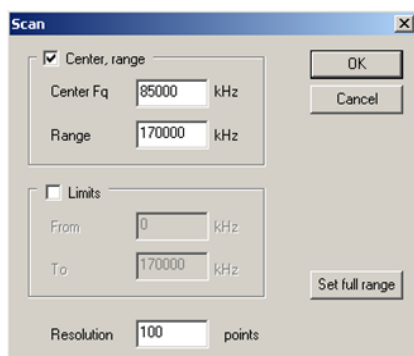

Figure D-5: 100 points and 'Set full range'

- The progress of the scan is displayed on the status bar (bottom left of the AntScope window). Wait until the scan is finished.

- Use this measurement for calibration. Select **Configure > Save calibration > as "open"** as shown in Figure D-6.

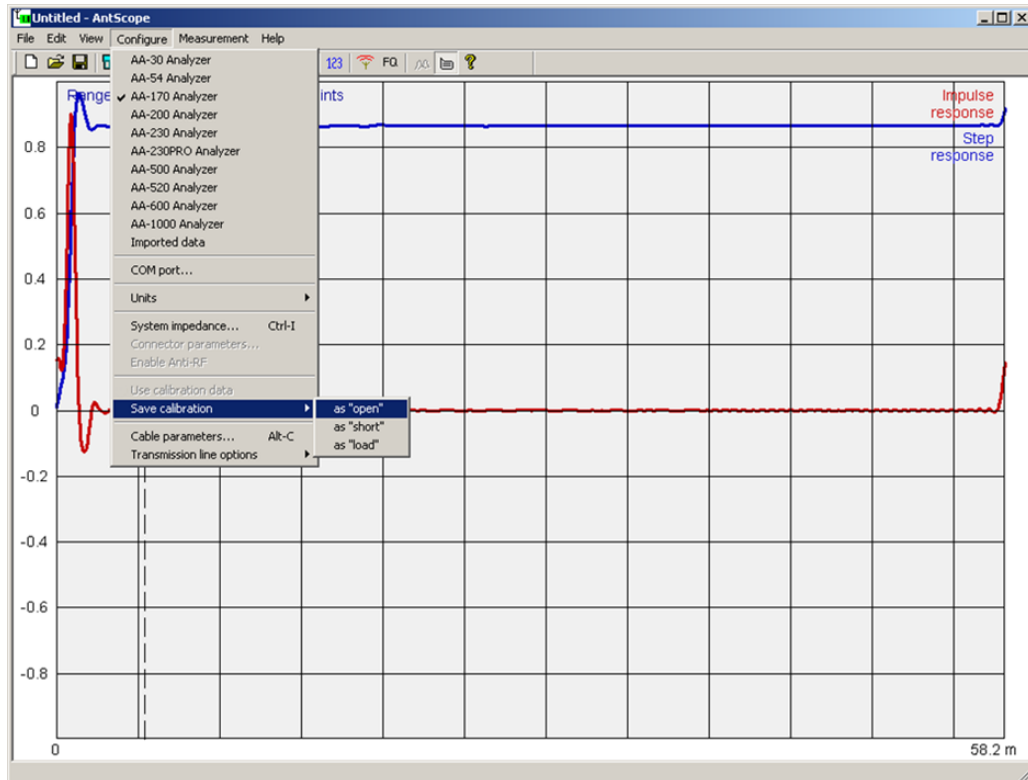

Figure D-6: Save calibration as "open"

- Select **File > Save As** and type the filename `calibOpen` as shown in Figure D-7 to save the data in the folder created in Step 1 for this Bushing Adaptor.

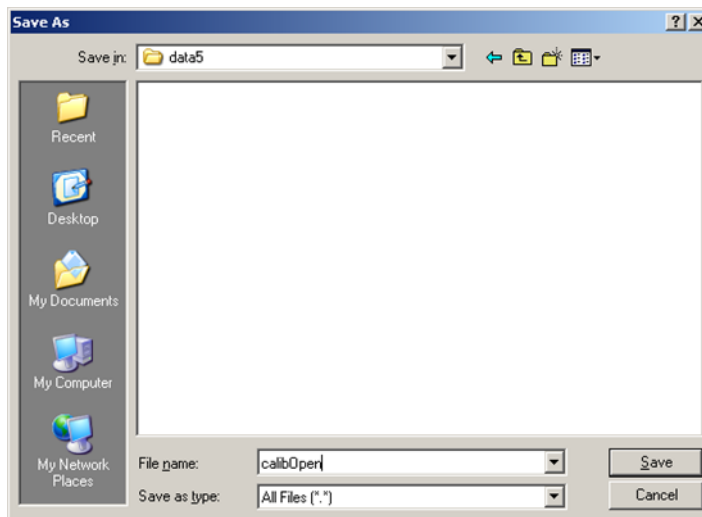

Figure D-7: Save "open" calibration data

- Connect the clips to each other as shown in Figure D-9 and run another measurement (press **F8** or click the button). Select **Save calibration > as "short"** and type the filename `calibShort`.
- Connect the 50 Ω resistor across the clips as shown in Figure D-10 and run another measurement. Select **Save calibration > as "load"** and type the filename `calibLoad`.



Figure D-8: Open calibration

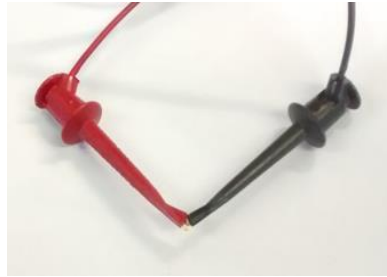

Figure D-9: Short calibration

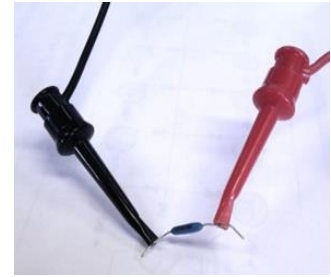

Figure D-10: Load calibration

14. Select the **Configure** menu item and ensure that **Use calibration data** is checked as shown in Figure D-11.

Note: If the calibration is used, a message stating *“Using OSL calibration”* is shown on the top left of the graph.

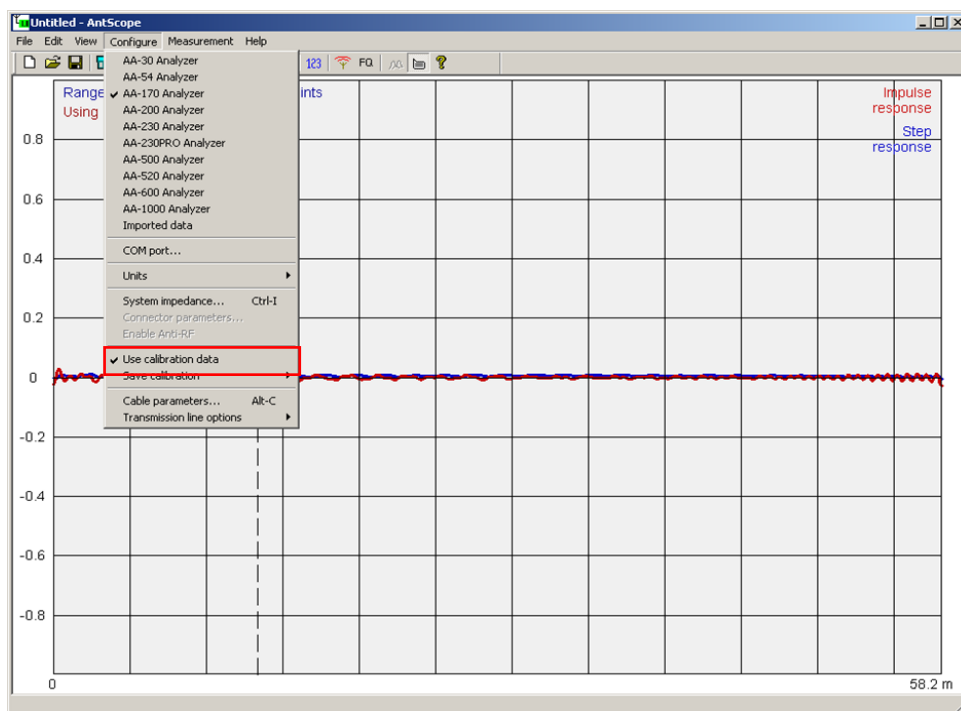





Figure D-11: Use calibration data

15. Select **View > Phase** to change the display.
16. Connect the clips to the Bushing Adaptor using the short cables in the adaptor's connector as shown in Figure D-12.



Figure D-12: Bushing adaptor measurement

17. Run another measurement (press **F8** or click the  button). Select **File > Save as** and type the filename adaptorOnly.
18. Connect the Bushing Adaptor as outlined in Section 5.2 Bushing Adaptor Connections.
19. Redo the measurement (press **F8** or click the  button). Select **File > Save as** and type the filename adaptorInstalled.
20. Click the  button to show both sets of data on the graph (the previous scan as well as the latest scan) as shown in Figure D-13.

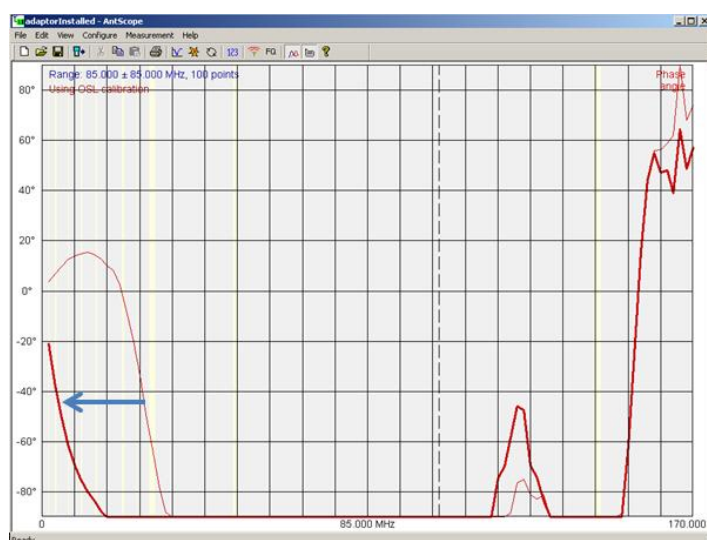

Figure D-13: Data analysis

21. The Bushing Adaptor internal pin is correctly installed if the phase change frequency changes as shown in Figure D-13. Otherwise there is no electrical contact and the installation must be terminated and the original test tap covers replaced.
22. Record the Manufacturer nameplate information in Table D-1: Results (below) for each bushing: Serial Number, PF%, C1, C2 and Temperature. Photograph the bushing plate where these values are listed. The plate pictures must be stored with the installation report, commissioning report and the antenna analyser data.
23. Record the Bushing Adaptor ID in the Results table. If installing more than one MMTS (for multiple single phase transformers) also record which temperature sensor is associated with this bushing.
24. Repeat steps 16 to 23 for each Bushing Adaptor installation on the transformer.

25. For each Bushing Adaptor, test the continuity between the coaxial cable shield and ground at the cabinet as shown in Figure D-14. It should be less than 5 Ω . Record this measurement in the Results table.

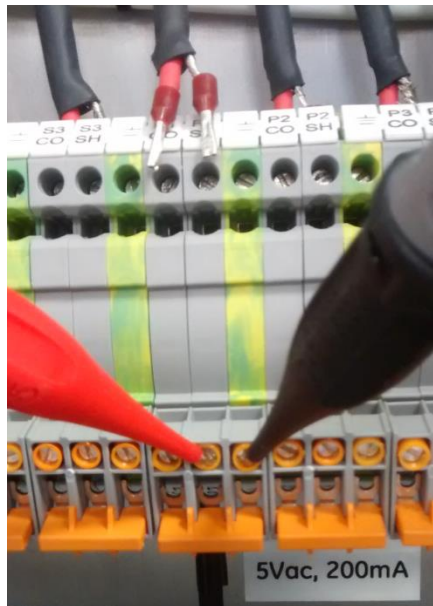

Figure D-14: Resistance between cable shield and ground

26. For each Bushing Adaptor, measure the resistance between the coaxial cable core and the shield as shown in Figure D-15. Record this measurement as $[R1]$ in the Results table. It should be less than 3000 Ω and within 5% of the Bushing Adaptor nominal resistance in **Calibration > Bushing Adaptor > Input Impedance**. Refer to the Intellix™ BMT 330 Service Manual.

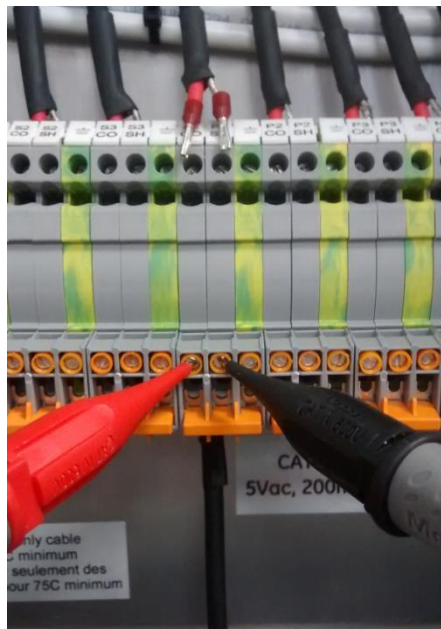

Figure D-15: R1 resistance measurement

27. For each Bushing Adaptor input, measure the resistance across the pins of the terminals as show in Figure D-16. Record this measurement as $[R2]$ in the Results table. It should be less than 2000Ω and within 5 % of the input channel impedance in **Calibration > PCB > Phase Voltage > Input Impedance**. Refer to the Intellix™ BMT 330 Service Manual.



Figure D-16: R2 resistance measurement

28. Reconnect all the coaxial cables.
29. Retest the resistance across the two screws of the connector as shown in Figure D-15 for each Bushing Adaptor. Record this measurement as $[R3]$ in the Results table.
30. Ensure that the measurement of $[R3]$ is within 5% of the total input resistance $[R_{input}]$ calculated from $[R1]$ and $[R2]$ for each input.

Note: The total input resistance $[R_{input}]$ is calculated as $[R_{input}] = 1 / (1/[R1] + 1/[R2])$

31. Store a completed copy of the Results table with the transformer maintenance documents.
32. Once the transformer is energised and the grounding switches are in the operational position (not grounded), measure the voltage drop across the core and the shield at the block terminals of the coaxial cables connected to the Bushing Adaptors and record these voltages in the Results table. These voltages must be within 0.9 to 1.4 Vrms.

Note: This does not apply to the neutral inputs.

Table D-1: Results

Date: -----		Primary B (A1) Ser No:	Primary B (B1) Ser No:	Primary C (C1) Ser No:	Primary B (D1) Ser No:	Secondary A (A2) Ser No:	Secondary B (B2) Ser No:	Secondary C (C2) Ser No:	Secondary C (D2) Ser No:
STEP 23:	Bushing Adaptor ID								
STEP 23:	MMTS #								
STEP 21:	Bushing Adaptor Internal Pin Correctly Installed								
STEP 22:	Manufacturer Nameplate Power Factor % [PF%]								
STEP 22:	Manufacturer Nameplate Capacitance [C1]								
STEP 22:	Manufacturer Nameplate Capacitance [C2]								
STEP 22:	Temperature at which nominal values were measured [T]								
STEP 25:	Shield to ground resistance (<5 Ohm)								
STEP 26:	Cable core to shield resistance [R1]								
STEP 27:	Board PCBA input resistance [R2]								
STEP 28:	Measured resistance after reconnection [R3]								
STEP 30:	[R3] within 5% of the [R _{input}] (Yes or No)								
STEP 32	Measured voltage across co-axial input (Vrms)								

This appendix details the steps to update the communications settings for the optional Kalkitech module (if required at the time of installation). Figure E-1 illustrates the connectivity provided by the Kalkitech module.

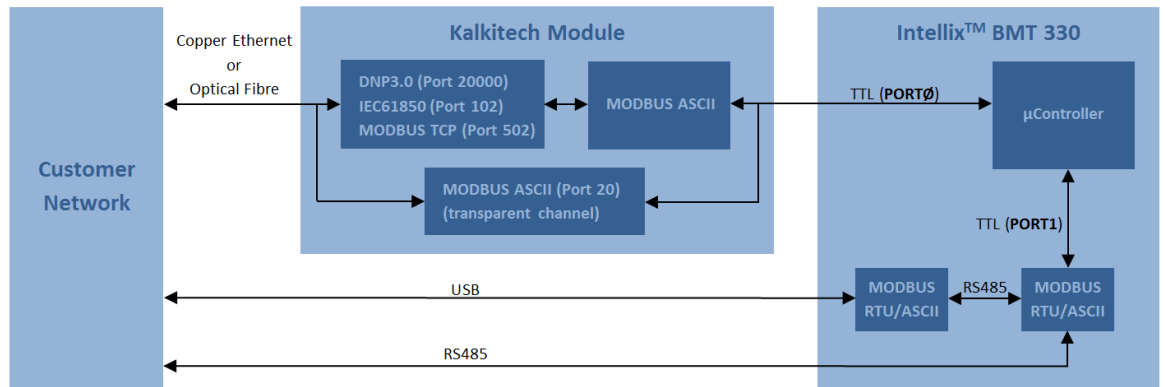

Figure E-1: Communication options between the BMT 330 and a customer network

E.1 Network Settings

For a computer to access the optional communications module, the computer must be set up to communicate on the same network. This is achieved by manually setting the computer network adaptor configuration as follows:

- IP Address: 192.168.0.xxx¹ ¹ where xxx can take any value in the range 2-254, except for 121, which is the pre-assigned default IP address for the communications module.
- Subnet Mask: 255.255.255.0
- Default Gateway: 192.168.0.1

The communications module has the following default TCP Port settings (limited by the communications options purchased):

Table E-1: Default TCP Port settings for communications module

Module Ethernet Connection	Purpose	Default TCP Port
Modbus TCP	Customer SCADA	502
DNP3	Customer SCADA	20000
IEC61850	Customer SCADA	102
Modbus ASCII Over TCP/IP - transparent channel	BMT Monitor Application Software	20

Hardware or software firewalls should be disabled or set to enable communications on the assigned IP addresses and ports.

A useful indication that the communications module has been detected is when the network icon on the taskbar reports an issue as shown in Figure E-2.



Figure E-2: Network status

E.2 EasyConnect software installation

Should it be necessary to alter the communications module IP settings from the factory default, EasyConnect software will need to be installed as described in the steps below. EasyConnect can be found on the CD shipped with the Intellix™ BMT 330.

1. Copy the **EasyConnect.4.10.0 zip** file to a local PC as shown in Figure E-3.

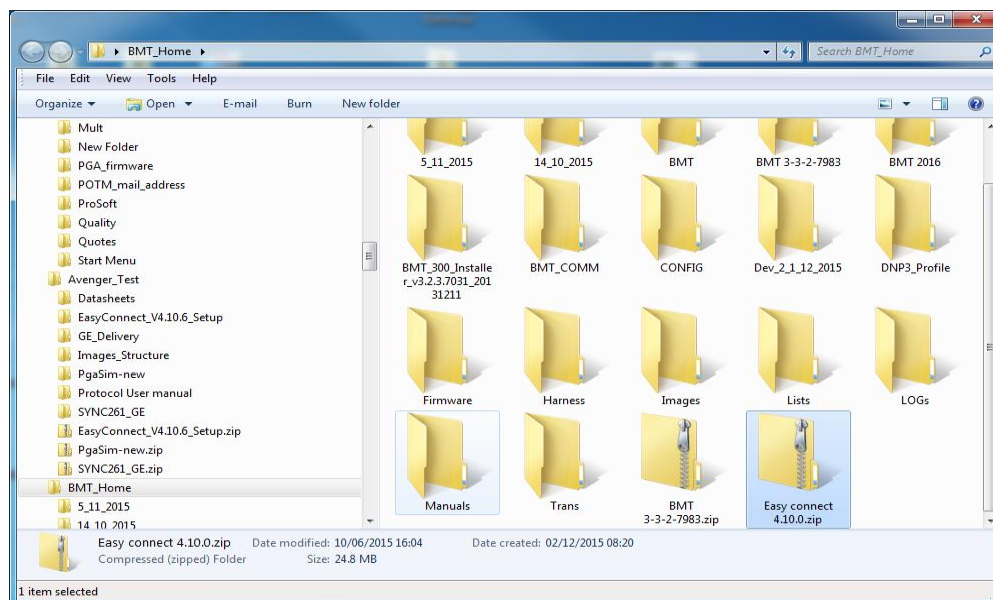

Figure E-3: EasyConnect 4.10.0.zip file

2. Right click the **EasyConnect 4.10.0.zip** file and extract the software application to a folder on the local PC as shown in Figure E-4.

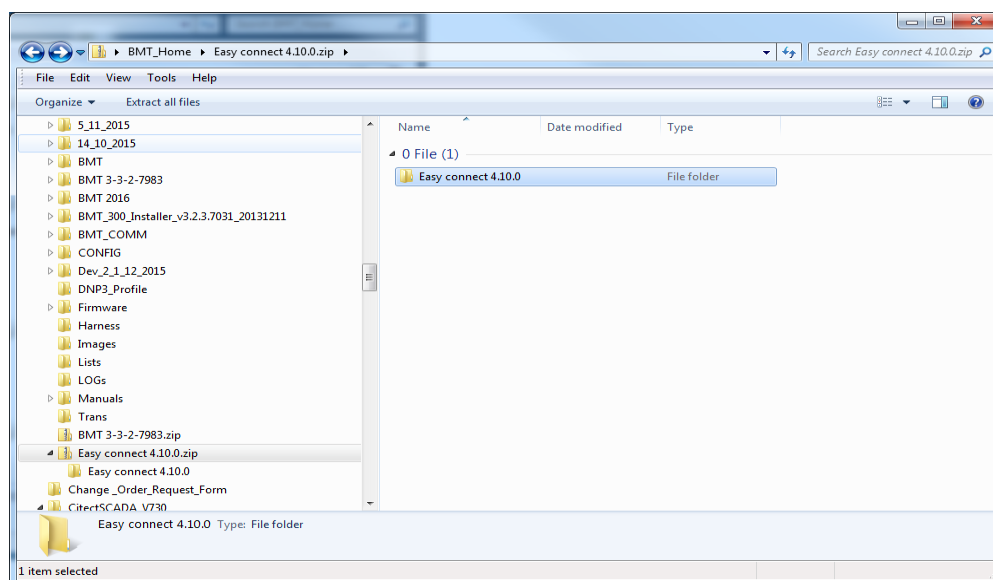

Figure E-4: EasyConnect 4.10.0 folder

3. Open the **EasyConnect 4.10.0** folder and double-click the **Setup.exe** file to install the software application as shown in Figure E-5.

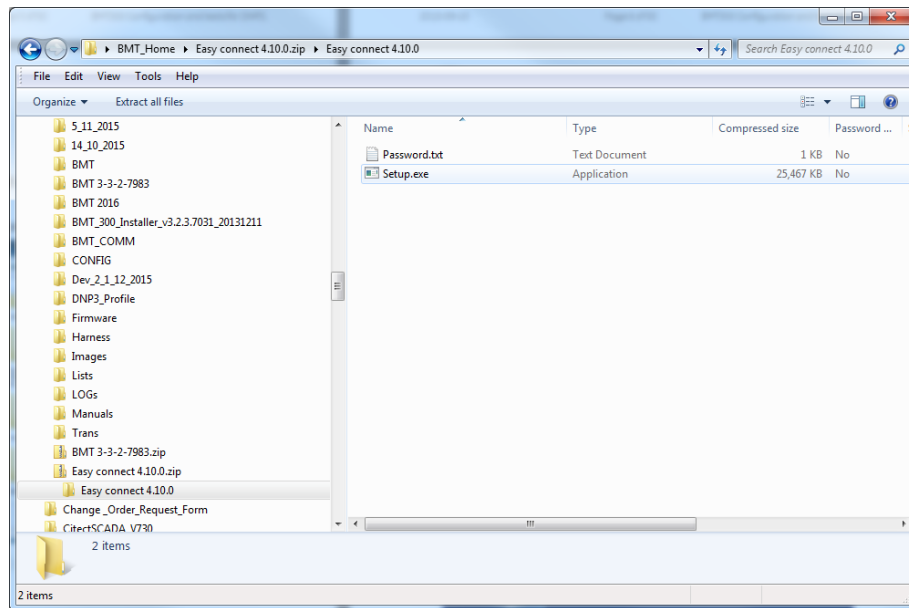

Figure E-5: EasyConnect Setup.exe file

4. The 'EasyConnect - InstallShield Wizard' opens on the 'License Agreement' window as shown in Figure E-6. Select **I accept the terms...** and click **Next** to continue.

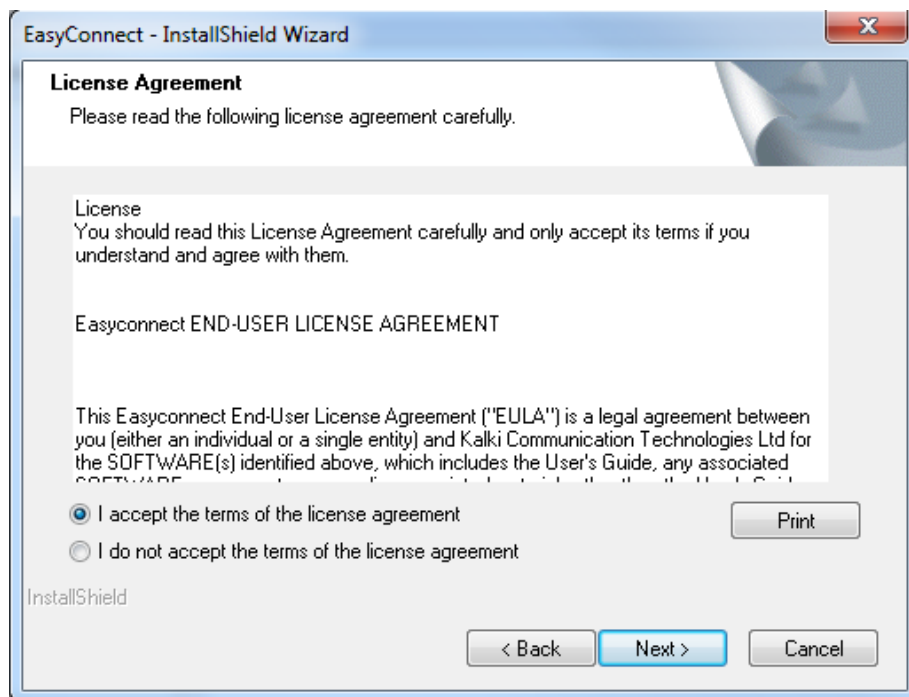

Figure E-6: License Agreement

5. The 'Choose Destination Location' window displays as shown in Figure E-7. Click **Next** to accept the default installation folder.

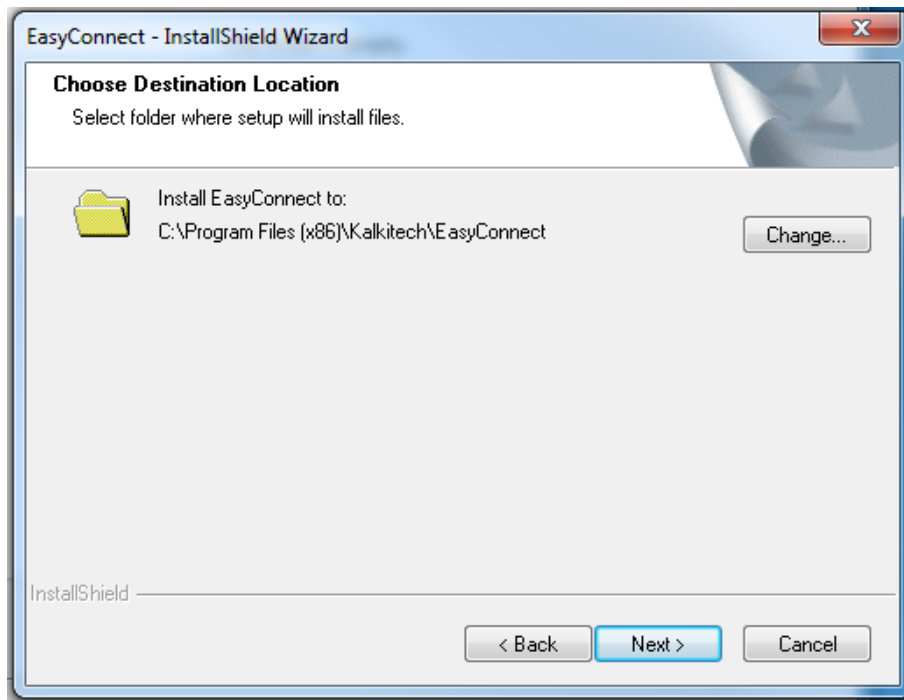

Figure E-7: Choose Destination Location

6. The 'Ready to Install the Program' window displays as shown in Figure E-8. Click **Install** to start the installation.

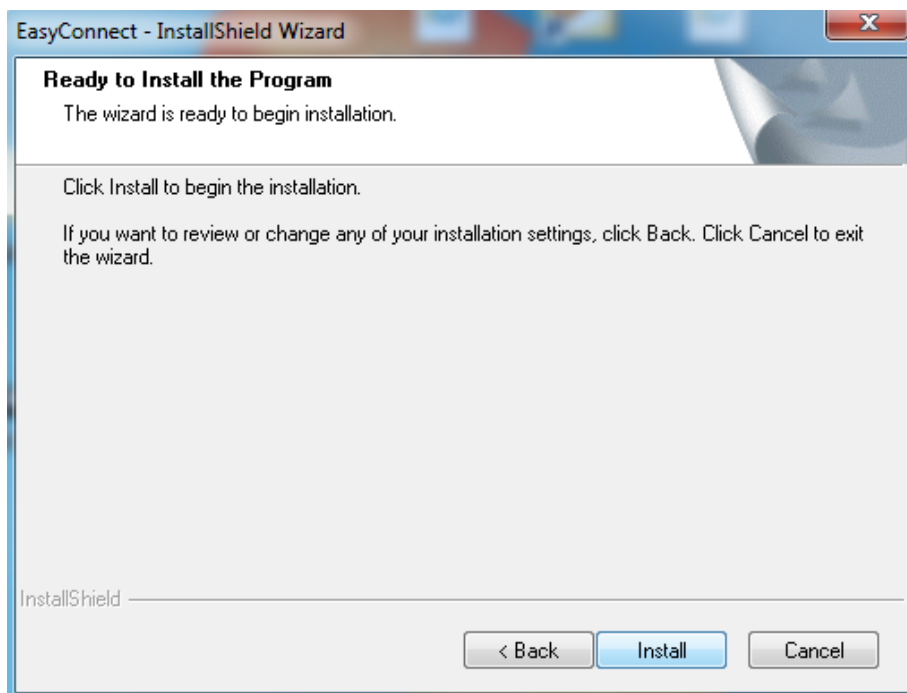

Figure E-8: Ready to Install the Program

7. The 'Setup Status' window shows the progress of the installation as shown in Figure E-9.

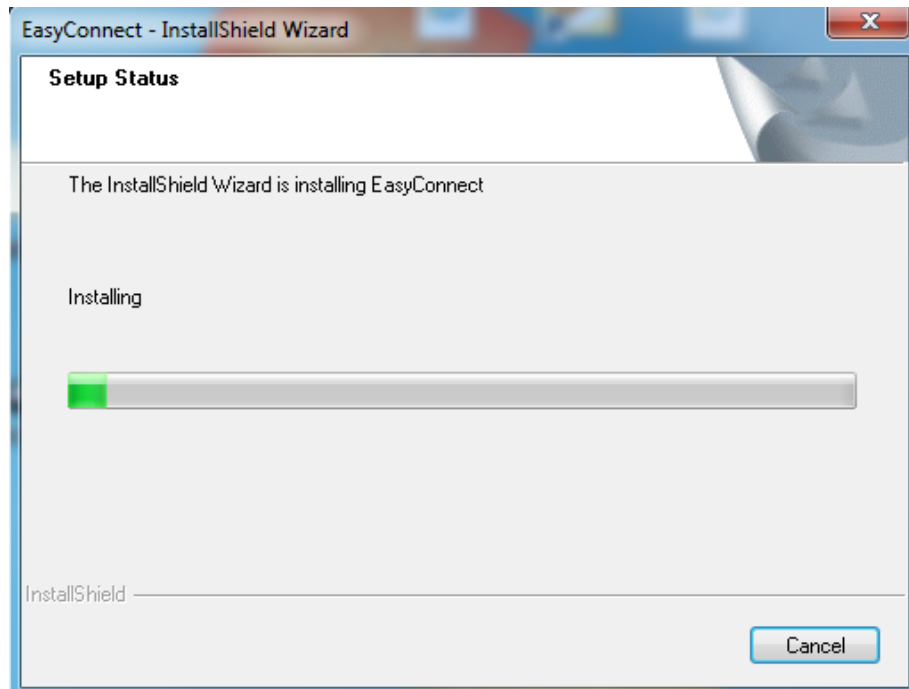

Figure E-9: Setup Status

8. The 'InstallShield Wizard Complete' window displays as shown in Figure E-10. Click **Finish** to exit the Wizard.

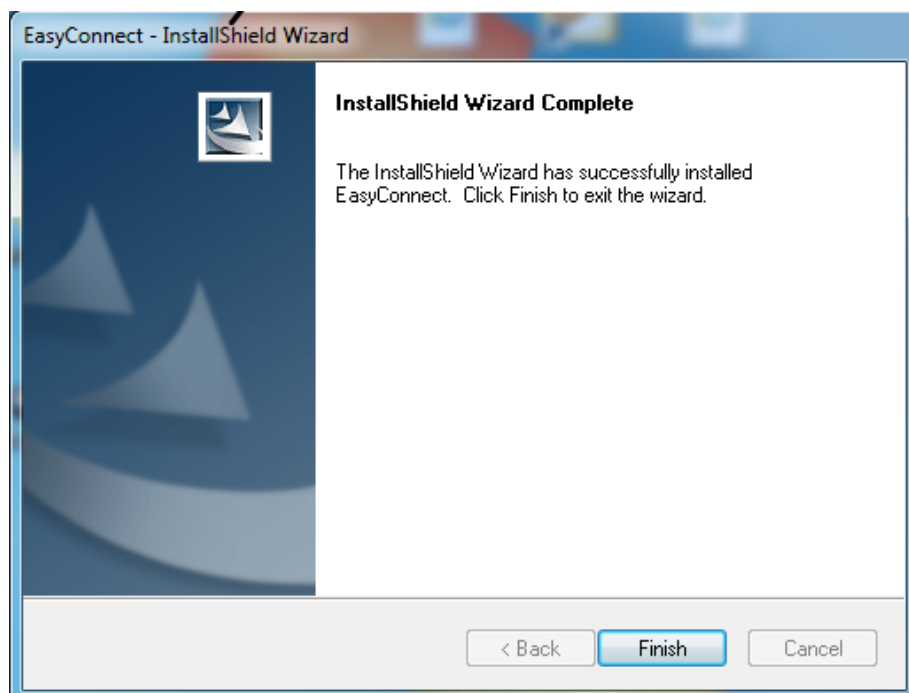

Figure E-10: InstallShield Wizard Complete

E.3 Communications module configuration

The EasyConnect software can be used to interrogate the communications module settings. This allows the IP address (and other settings) to be changed and uploaded if required.

1. Start the EasyConnect software application (navigate to the 'Kalkitech\EasyConnect' folder and double-click the **EasyConnect.exe** file or use the EasyConnect shortcut as shown in Figure E-11.

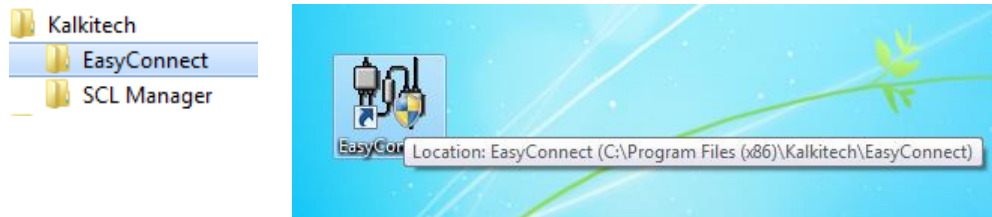



Figure E-11: EasyConnect Installation folder & shortcut

2. The EasyConnect application opens as shown in Figure E-12. Click the **Upload** button  to change the IP address.

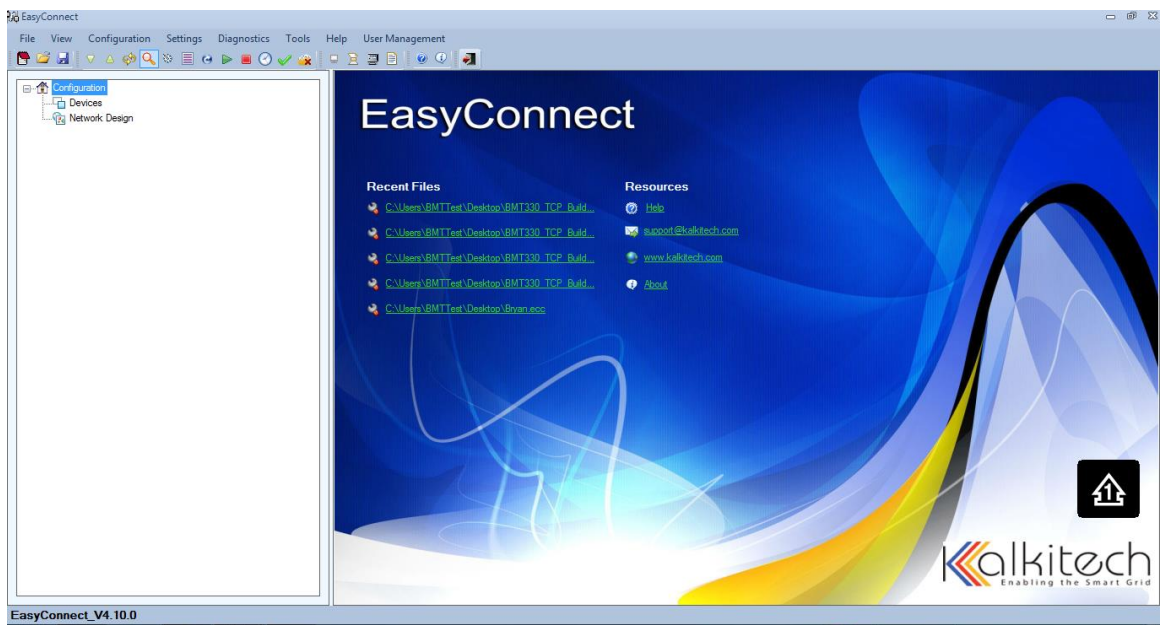

Figure E-12: EasyConnect main screen

- In the Upload dialog box, type the IP address (the default is 192.168.0.121), uncheck the LAN settings box and click the **Upload** button as shown in Figure E-13.

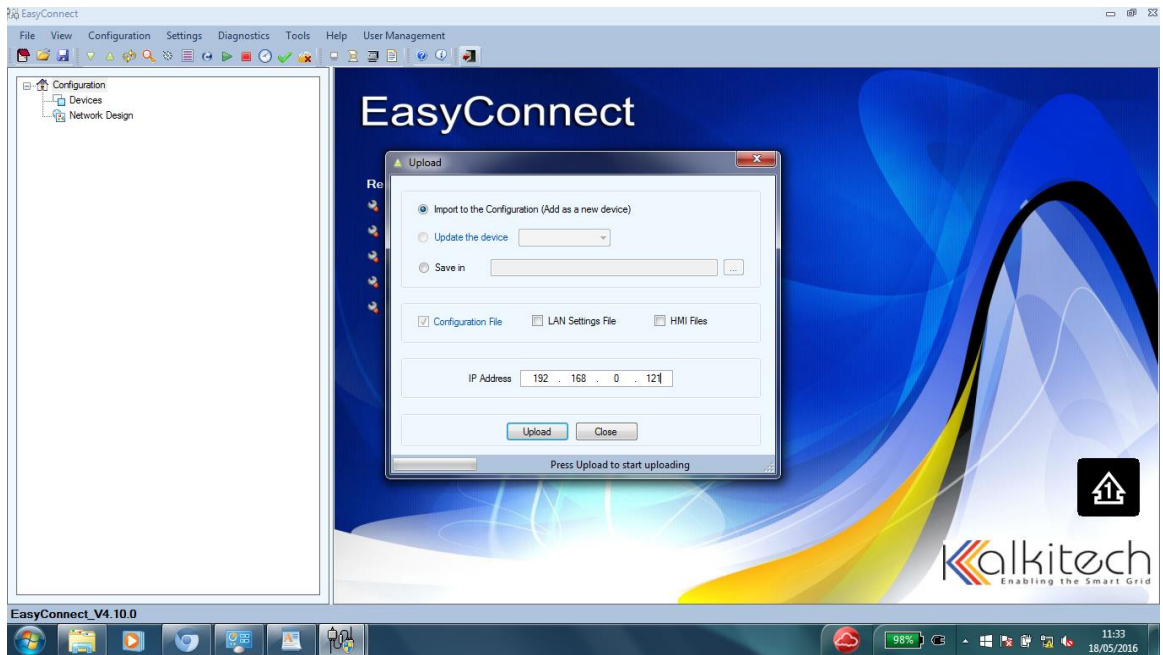

Figure E-13: Upload Kalkitech module settings

- In the left-hand tree view, select **Protocol Configuration**. When the new settings are received from the communications module, the configuration tree updates as shown in Figure E-14.

Note: The number of configured channels on the communications module may show less than four (depending on the configuration purchased).

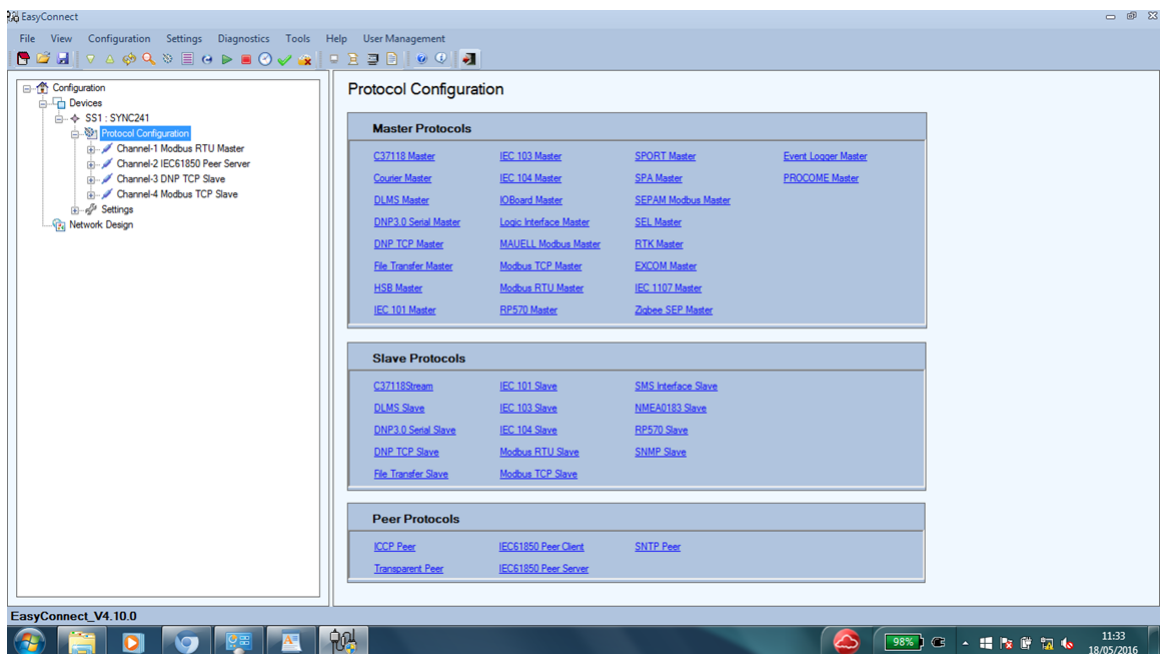

Figure E-14: Protocol Configuration

5. To change the IP address from the default value, select **Settings > IP Configuration** as shown in Figure E-15.

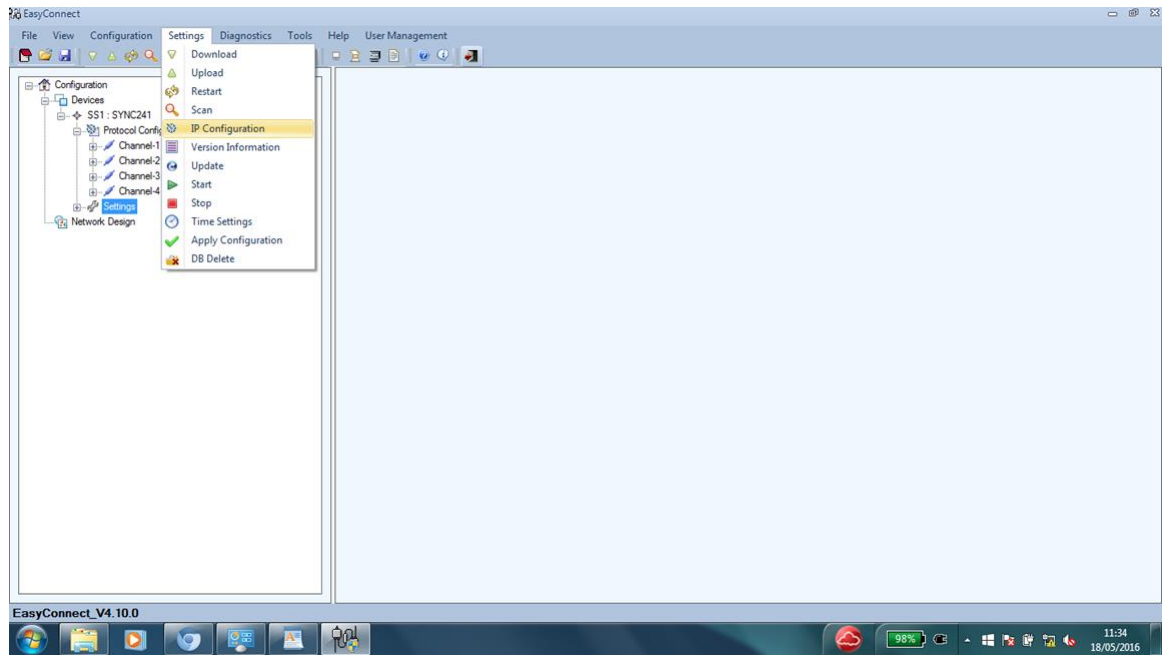

Figure E-15: IP Configuration

6. The Lan Settings dialog box displays the Device name and current IP Address as shown in Figure E-16. Type the new IP address below (for example, 192.168.0.122), but leave the Subnet and Gateway on the default values and click **OK**.

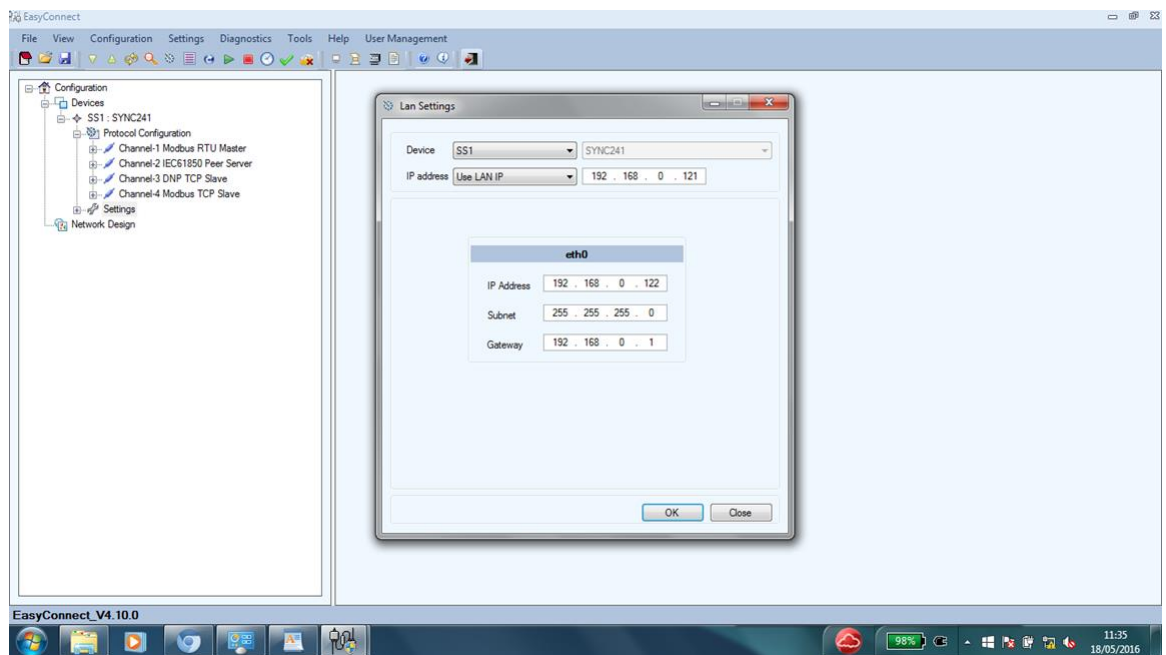

Figure E-16: LAN settings

7. The Lan Settings confirmation message prompts for a device restart. Click **Yes** to continue.

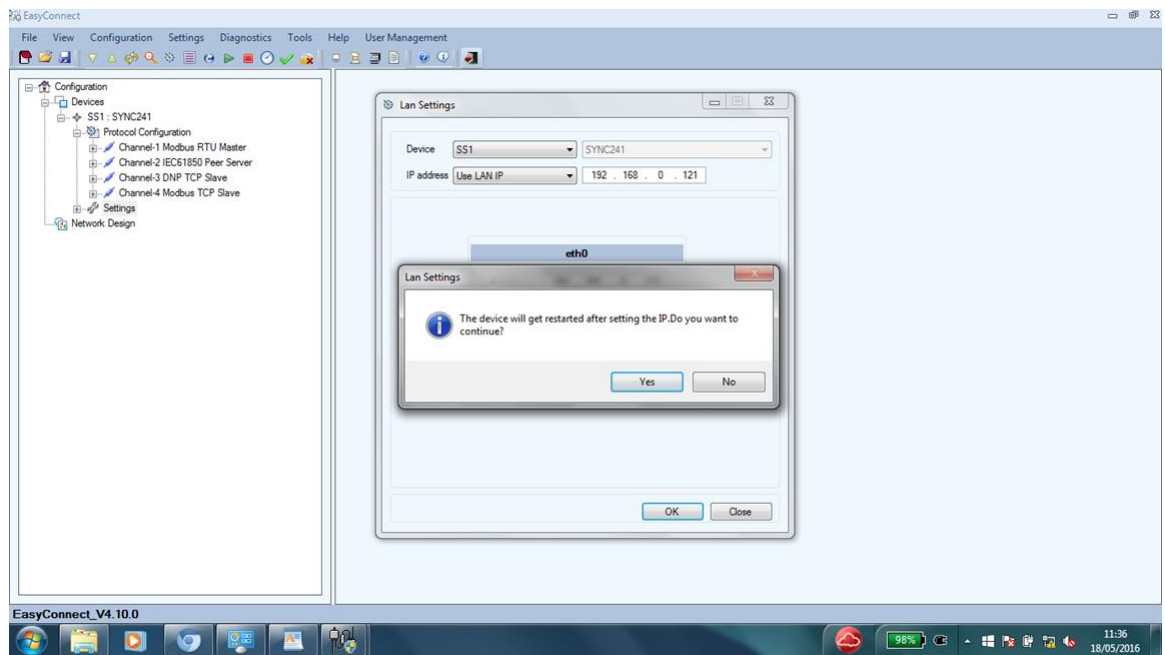

Figure E-17: Restart confirmation

8. The progress bar and subsequent Lan Settings confirmation message as shown in Figure E-18 indicates a successful change of IP address. Click **OK**.

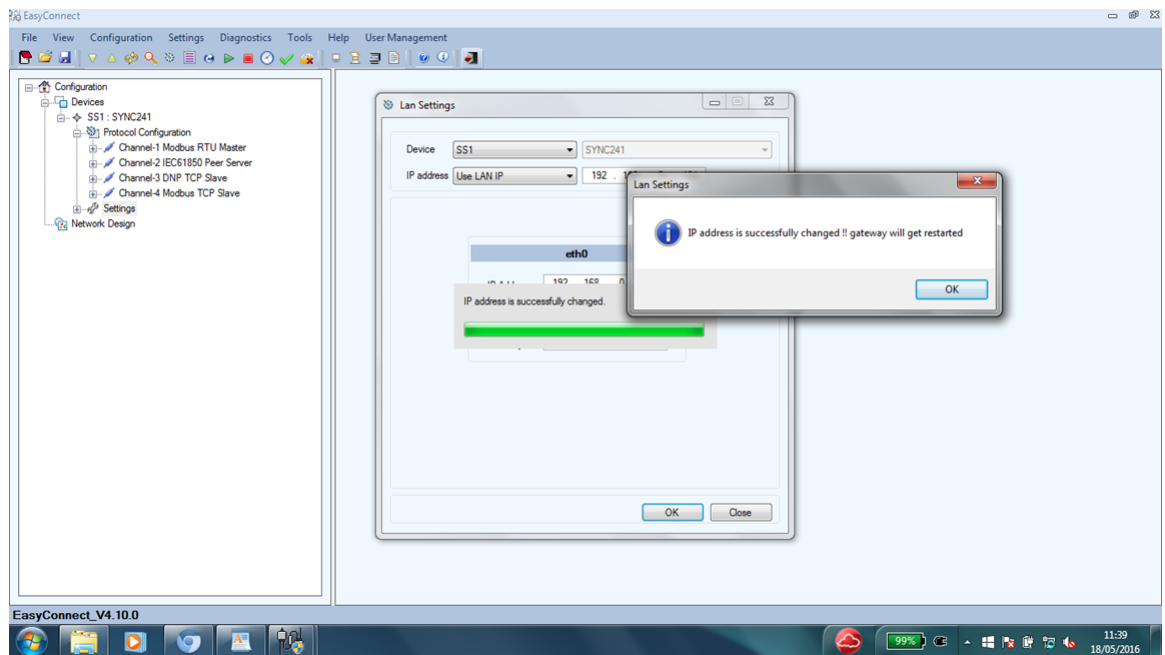





Figure E-18: IP address confirmation

The communications module will restart and communications will be available using the new IP address.



Note: If the communications module has been reconfigured to a different network, then the host computer must also be reconfigured to communicate on the new network and IP address/port.

Table F-1: Front panel lights

Light Colour	Light Symbol	Meaning
Green	POWER 	AC power applied
Blue	SERVICE 	Service Required. Triggered by one of: <ul style="list-style-type: none"> • Low Bushing current warning • Power system frequency warning • No signal warning • Bushing Adaptor Resistance failure warning
Yellow	CAUTION 	A measured parameter has exceeded a user-programmed 'Hi' alarm threshold.
Red	ALARM 	A measured parameter has exceeded a user-programmed 'Hi-Hi' alarm threshold.

The troubleshooting actions outlined in Table G-1 can be performed onsite by a qualified General Electric technician or by authorised personnel.

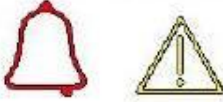
Table G-1: Problems and Actions

Icon(s)	Problem	Action(s)
<p>POWER</p> 	The green Power light indicator does not turn on.	<ul style="list-style-type: none"> • Check the AC power supply. • Check the protective circuit breaker is set. • Check the 3 A fuses in the Live and Neutral (see Figure 5-24).
<p>ALARM CAUTION</p> 	The red Alarm or amber Caution light indicator is flashing.	<ul style="list-style-type: none"> • Reset the alarm. • Check the Alarm or Caution level setting.
<p>SERVICE</p> 	The blue Service light indicator is flashing.	Maintenance action is required. Contact GE Technical Support.



WARNING: The product may have more than one source of power supply, e.g. the alarm relays may be from an independent AC supply. Disconnect all supplies at their source before servicing. Apply LOTO procedures.



WARNING: The product requires no periodic maintenance. If modifications must be made, switch off the external circuit breaker and ensure that the green LED power indicator is off. Once inside the product, disconnect the nine (9) grounding switches by placing the grounding bar at the screws and tightening them.

GE Grid Solutions (UK) Ltd

Lissue Industrial Estate East
Unit 1, 7 Lissue Walk, Lisburn, Co. Antrim
Northern Ireland, United Kingdom BT28 2LU
www.gegridsolutions.com/md.htm

For further assistance or queries please contact:

Customer Service Centre (24 hours a day, 365 days a year)
T +44 1785-250-070 (United Kingdom)
T 1-800-361-3652 (United States and Canada)
T +1 514-420-7460 (worldwide)
GA.support@ge.com

GE, the GE monogram and Intellix are trademarks of the General Electric Company. Other company or product names mentioned in this document may be trademarks or registered trademarks of their respective companies.

GE reserves the right to make changes to specifications of products described at any time without notice and without obligation to notify any person of such changes.

This manual is accurate at the time of writing. For the latest release, please visit:
<http://www.gegridsolutions.com/md/catalog/BMT330.htm>.

Copyright, General Electric Company, 2022. All Rights Reserved.



Building a world that works